

P ▲ R ▲ D O X™

2016 - 2017



Life Enhancing Technology Solutions Since 1989

At Paradox, our goal is to deliver innovative and leading products, together with our team of Distributors, to our Customers.

The Paradox team is always proud to introduce service and exceed the expectations of our Distributors and Users.

As a privately owned company, myself, our managers and the whole Paradox team are available and proud to develop and serve.

With three locations of intensive R&D, we continue to invest heavily in order to develop and continue the journey started in 1989.

Our products are sold to, and through, our loyal Distributors in over 80 countries, many of whom have been with us for over 25 years.

Since the beginning, Paradox's approach has been to work hand-in-hand, as a team with our Distributors and our Suppliers, to support Installers and Users. This teamwork served to realize our mutual goal of providing design-led, cutting-edge technology and service. We are convinced that this unique formula makes us special in today's world.

As always, I thank our Distributors, Suppliers and Paradox's dedicated Employees for the hard work and loyalty over the years, and most of all, our Dealers and Users throughout the world.

Comments and feedback about the catalog or other issues can be directed to VIPfeedback@paradox.com.

Yours Sincerely



Shmuel HersHKovitz
Founder and Owner

TABLE OF CONTENTS

01 COMPATIBILITY TABLES

04 VIDEO MONITORING

- 04 HD78
- 04 Insite GOLD App

05 EVO

- Maximum Flexibility**
- Up to 192 Zones and 8 Partitions
- 06 Control Panels
- 07 Keypads
- 08 Detectors
- 13 Magnetic Contact
- 13 Zone Expanders
- 15 Access Control
- 17 Special Modules

18 SPECTRA

- Simple Scalability**
- Up to 32 Zones and 2 Partitions
- 19 Control Panels
- 21 Keypads
- 24 Zone Expanders
- 25 Special Modules

26 MAGELLAN

- Built-in Wireless Capabilities**
- Up to 32 Zones and 2 Partitions
- 27 Control Panels
- 28 Keypads
- 28 Zone Expanders
- 29 All-in-One Console
- 29 Special Modules
- 29 Power Adaptors

30 REMOTE CONTROLS

30 DETECTORS

- 33 Wireless
- 37 Wireless Safety
- 38 Wired
- 44 Accessories

45 WIRELESS SIRENS

46 CELLULAR / IP / VOICE

- 46 GPRS / IP Receiver
- 47 Cellular
- 48 Voice
- 48 IP

49 SECURITY ACCESSORIES

50 SOFTWARE / MOBILE APPS

51 INDEX

52 ICON DESCRIPTION

52 LEGAL INFORMATION

COMPATIBILITY TABLE

▲ Compatible with panel

Requires RTX3 (SP/EVO) / K32LX (SP) / K641LX (EVO)

Requires RX1 (SP) / RTX3 (SP/EVO) / K32LX (SP)

	Page	EVOHD	EVO192	SP4000	SP5500	SP6000	SP65	SP7000	MG5000	MG5050	MG6250
Keypads											
TM50	07, 21	▲	▲	▲	▲	▲	▲	▲	▲	▲	-
K641+	07	▲	▲	-	-	-	-	-	-	-	-
K641LX	07	▲	▲	-	-	-	-	-	-	-	-
K641R	08	▲	▲	-	-	-	-	-	-	-	-
K656	08	▲	▲	-	-	-	-	-	-	-	-
K32LX	21	-	-	▲	▲	▲	▲	▲	-	-	-
K32LCD+	22	-	-	▲	▲	▲	▲	▲	▲	▲	-
K35	22	-	-	▲	▲	▲	▲	▲	▲	▲	-
K37	23	-	-	-	▲	▲	▲	▲	▲	▲	▲
K32RF	23	-	-	-	▲	▲	▲	▲	▲	▲	▲
K32+	24	-	-	▲	▲	▲	▲	▲	▲	▲	-
K10V / K10H	24	-	-	▲	▲	▲	▲	▲	▲	▲	-
K636	24	-	-	▲	▲	▲	▲	▲	▲	▲	-
Expanders											
ZX1	13	▲	▲	-	-	-	-	-	-	-	-
ZX4	13	▲	▲	-	-	-	-	-	-	-	-
ZX8	13	▲	▲	▲	▲	▲	▲	▲	▲	▲	-
ZX8D	14	▲	▲	-	-	-	-	-	-	-	-
ZX8SP	26	-	-	▲	▲	▲	▲	▲	▲	▲	-
ZX16D	14	▲	▲	-	-	-	-	-	-	-	-
ZX32D	14	▲	▲	-	-	-	-	-	-	-	-
RTX3	15	▲	▲	▲	▲	▲	▲	▲	-	-	-
RX1	25	-	-	▲	▲	▲	▲	▲	-	-	-
Control Module											
ACM12	15	▲	▲	-	-	-	-	-	-	-	-
Cellular / IP / Voice											
IPR512	46	▲	▲	▲	▲	▲	▲	▲	▲	▲	▲
IPRS-7	46	▲	▲	▲	▲	▲	▲	▲	▲	▲	▲
PCS250 / PCS250G	47	▲	▲	▲	▲	▲	▲	▲	▲	▲	-
PCS260 / PCS265	47	▲	▲	▲	▲	▲	▲	▲	▲	▲	-
IP150	48	▲	▲	▲	▲	▲	▲	▲	▲	▲	-
VDMP3	48	▲	▲	▲	▲	▲	▲	▲	▲	▲	-
GPRS14	29	-	-	-	-	-	-	-	-	-	▲

▲ Compatible with panel

Requires RTX3 (SP/EVO) / K32LX (SP) / K641LX (EVO)

Requires RX1 (SP) / RTX3 (SP/EVO) / K32LX (SP)

	Page	EVOHD	EVO192	SP4000	SP5500	SP6000	SP65	SP7000	MG5000	MG5050	MG6250
Card Readers											
R915	15	▲	▲	-	-	-	-	-	-	-	-
R910	16	▲	▲	-	-	-	-	-	-	-	-
Proximity Cards											
C702	16	▲	▲	-	-	-	-	-	-	-	-
C706	16	▲	▲	-	-	-	-	-	-	-	-
C704	16	▲	▲	-	-	-	-	-	-	-	-
C705	16	▲	▲	-	-	-	-	-	-	-	-
Remote Controls											
REM101 / REM15 / REM1	30	▲	▲	▲	▲	▲	▲	▲	▲	▲	▲
REM2 / REM25 / REM3	30	▲	▲	-	▲	▲	▲	▲	▲	▲	▲
RAC1	16	▲	▲	▲	▲	▲	▲	▲	▲	▲	▲
Video Verification											
HD78	04	▲	▲	-	▲	▲	-	▲	-	-	-
Magnetic Contacts											
ZC1	13	▲	▲	-	-	-	-	-	-	-	-
DCT10	36	▲	▲	▲	▲	▲	▲	▲	▲	▲	▲
DCT2	36	▲	▲	▲	▲	▲	▲	▲	▲	▲	▲
DCTXP2	37	▲	▲	▲	▲	▲	▲	▲	▲	▲	▲
Wireless Sirens											
SR130	45	-	-	-	▲	▲	▲	▲	▲	▲	▲
SR150	45	-	-	-	▲	▲	▲	▲	▲	▲	▲
Special Modules											
PRT3	17	▲	▲	-	-	-	-	-	-	-	-
HUB2	17	▲	▲	▲	▲	▲	▲	▲	▲	▲	-
PGM4	17	▲	▲	▲	▲	▲	▲	▲	▲	▲	-
2WPGM	29	▲	▲	-	▲	▲	▲	▲	▲	▲	▲
PS17	17	▲	▲	-	-	-	-	-	-	-	-
RPT1	25	-	-	-	▲	▲	▲	▲	▲	▲	▲
Software											
Insite GOLD App	04	▲	▲	▲	▲	▲	-	-	-	-	-
NEware	50	▲	▲	-	-	-	-	-	-	-	-
BabyWare	50	▲	▲	▲	▲	▲	▲	▲	▲	▲	▲
IP Exploring Tools	50	▲	▲	▲	▲	▲	▲	▲	▲	▲	-
InField	50	▲	▲	▲	▲	▲	▲	▲	▲	▲	▲

▲ Compatible with panel

Requires RTX3 (SP/EVO) / K32LX (SP) / K641LX (EVO)

Requires RX1 (SP) / RTX3 (SP/EVO) / K32LX (SP)

	Page	EVOHD	EVO192	SP4000	SP5500	SP6000	SP65	SP7000	MG5000	MG5050	MG6250
Security Accessories											
PS817	49	▲	▲	▲	▲	▲	▲	▲	▲	▲	-
307USB	49	▲	▲	▲	▲	▲	▲	▲	▲	▲	▲
PMC5	49	-	▲	▲	▲	▲	▲	▲	▲	▲	-
Detectors											
DM50	08	▲	▲	-	-	-	-	-	-	-	-
DM60	08	▲	▲	-	-	-	-	-	-	-	-
DM70	09	▲	▲	-	-	-	-	-	-	-	-
NVX80	12	▲	▲	▲	▲	▲	▲	▲	▲	▲	▲
PMD2P	33	▲	▲	▲	▲	▲	▲	▲	▲	▲	▲
PMD75	33	▲	▲	▲	▲	▲	▲	▲	▲	▲	▲
PMD85	35	▲	▲	▲	▲	▲	▲	▲	▲	▲	▲
NV5	41	▲	▲	▲	▲	▲	▲	▲	▲	▲	▲
DG55+	39	▲	▲	▲	▲	▲	▲	▲	▲	▲	▲
DG65+	39	▲	▲	▲	▲	▲	▲	▲	▲	▲	▲
DG75+	40	▲	▲	▲	▲	▲	▲	▲	▲	▲	▲
DG85	11	▲	▲	▲	▲	▲	▲	▲	▲	▲	▲
525DM	40	▲	▲	▲	▲	▲	▲	▲	▲	▲	▲
DG467	09	▲	▲	▲	▲	▲	▲	▲	▲	▲	▲
DG466	42	▲	▲	▲	▲	▲	▲	▲	▲	▲	▲
476	43	▲	▲	▲	▲	▲	▲	▲	▲	▲	▲
476PET	43	▲	▲	▲	▲	▲	▲	▲	▲	▲	▲
460	44	▲	▲	▲	▲	▲	▲	▲	▲	▲	▲
DG457	12	▲	▲	▲	▲	▲	▲	▲	▲	▲	▲
G550	36	▲	▲	▲	▲	▲	▲	▲	▲	▲	▲
GS250	37	▲	▲	▲	▲	▲	▲	▲	▲	▲	▲
SD360	37	▲	▲	▲	▲	▲	▲	▲	▲	▲	▲
950	44	▲	▲	▲	▲	▲	▲	▲	▲	▲	▲
NV780MX	10	▲	▲	▲	▲	▲	▲	▲	▲	▲	▲
NV35MX	10	▲	▲	-	-	-	-	-	-	-	-
NV780MR	34	▲	▲	▲	▲	▲	▲	▲	▲	▲	▲
NV35MR	35	▲	▲	▲	▲	▲	▲	▲	▲	▲	▲
NV35M	42	▲	▲	▲	▲	▲	▲	▲	▲	▲	▲
NV75M	38	▲	▲	▲	▲	▲	▲	▲	▲	▲	▲
NV75MX	38	▲	▲	-	-	-	-	-	-	-	-
NV75MR	34	▲	▲	▲	▲	▲	▲	▲	▲	▲	▲
NV75MW	38	▲	▲	▲	▲	▲	▲	▲	▲	▲	▲

Video Monitoring HD Camera

New!



HD78 / F Event-Driven Indoor Security IP Camera / Detector

► Features

- Security Event-driven - Files linked to events
- Models: HD78F Wi-Fi / Ethernet, HD78 Ethernet
- Remote access via Insite Gold free application and ParadoxMyHome DNS (annual charge)
- Google Drive cloud storage with no after-purchase charges
- 720P color streaming (HD264), HD audio
 - Internal storage: 20 minutes alarm and 20 minutes Video on Demand (VOD) / Record on Trigger (ROT)
- Free Insite Gold application
 - Easy installation and programming, viewing, arm / disarm, access and PGM activations
- Auto storage on Insite Gold when playing video files
- Pre-alarm -3 sec. recording
- Push notifications
- Built-in Security Grade Quad PIR detector
- Video Live Sharing - share live video streaming with up to 4 participants
- Night Illumination IR LEDs
- Compatible with Paradox Spectra (SP5500, SP6000, SP7000), EVO192 and EVOHD

► Specifications

Image Resolution	1280 x 720p
Image Sensor Type	1.4 megapixels, CMOS sensor
Streaming Video	360p H.264 10 FPS
Audio	16-bit, 16 kHz sampling rate, 32 Kb/s monostream
Detection Speed	0.2 to 2.5 m/s (0.6 to 11.5 ft/s)
Detection Range	12 x 12m (40 x 40 ft) / 110°
Camera Storage	2 GB, 20 minutes alarm and 20 minutes ROT / ROD File length - 10 seconds after last detection, for a maximum of 3 minutes
Input Voltage	11.2 to 16 Vdc
Current Consumption	350 mA Max - IR illumination ON 250 mA Nominal - IR illumination OFF
Operating Temperature	-20 to 40 °C (-4 to 104 °F)
Dimensions	15 x 7.5 x 5 cm (6 x 3 x 2 in.)

Top View

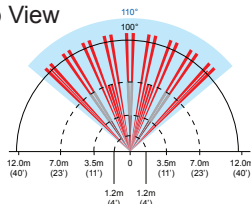

Side View

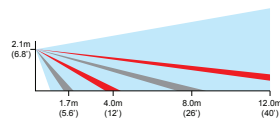

Paradox Insite GOLD Software

New!



Insite GOLD App Full Smartphone Control

► Features

- Multi-site
- Configure ParadoxMyHome Site
- Configure and program Camera site including Google Drive backup
- Push notification
- Panel Master full control
- View (VOD) play video event files
- Configure and control PGMs
- Control access doors (grant access, lock, unlock)
- Arm, Disarm system
- Panic buttons
- Android and iOS

► System Requirements

iPhone iOS V6.0 or higher

Android V4.2 - V.4.4.4 or higher

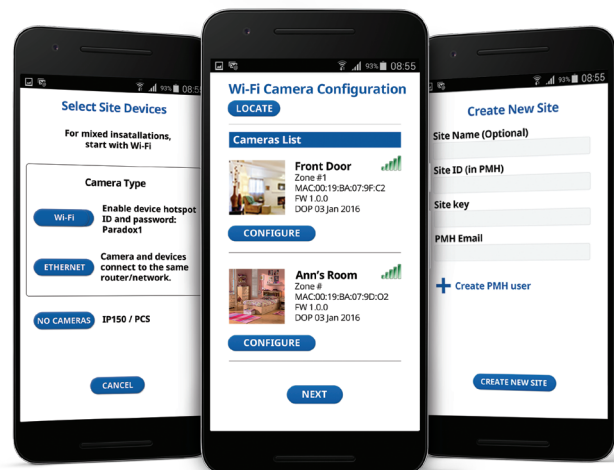

EVO systems provide the highest level of protection for banks, military and government sites, luxurious residential homes and any place where maximum security is essential. These systems are designed to be easy to use and their modular concept provides installers with work-saving features that make expanding, installing and servicing them quick and convenient.

Expand your system by adding plug-and-play expansion modules anywhere and in any combination on the 4-wire EVO bus. Modules are connected to the bus at the most convenient location and then their zone inputs are assigned to the desired zone and partition. Also, only a module's used inputs are assigned to zones in the system. Keyswitches, remote controls and unused module inputs do not use up zones. Once installed, all bus modules, including motion detectors, can be programmed remotely via a keypad or via the BabyWare PC software.

EVO integrates powerful access control solutions, enabling your alarm system database to manage access to up to 32 doors, and monitor their access from inside any partition. You can use BabyWare and NEware to manage permissions for all users and access. By merging security and access control, EVO increases your security system protection to an unprecedented level.

EVO
Compatibility Overview

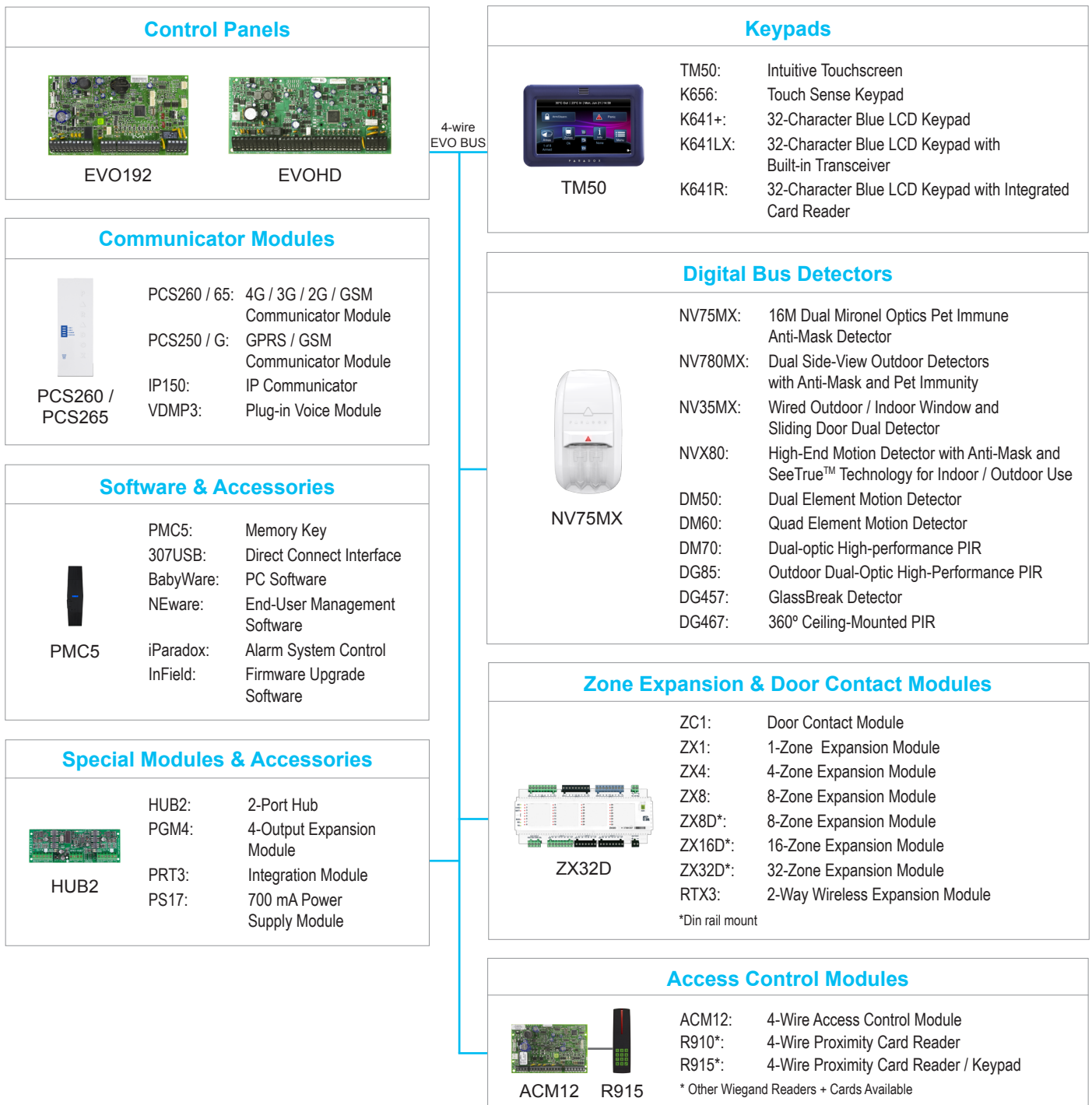

EVO

Control Panels Comparison



Features

	EVO192	EVOHD
Maximum Zones	192	192
On-Board Zones	8 (16 with ATZ)	8 (16 with ATZ + Tamper Input)
Partitions	8	8
Users	999	999
In-Field Firmware Upgradeable	▲	▲
Access Control	32 doors	32 doors
Events Buffered	2048	2048
PGMs	250 (5 on board)	250 (5 on board)
Siren	Wired	Wired
Total Expansion Modules	254	254
Landline Speed for Programming	300 Bps	300 / 1200 Bps

Specifications

Internal Power Supply	1.7A switching	2.5A switching
Input Voltage	16 Vac, 20 / 40 VA, 50-60 Hz	16 Vac, 40 / 75 VA, 50-60 Hz
Battery	12 Vdc, 7 Ah minimum	12 Vdc, 7 Ah minimum
Battery Charging Current	350 mA / 850 mA	Up to 1.5A
Auxiliary Output	12 Vdc, 700 mA, fuseless shutdown at 1.1A	13.8 Vdc 2A (requires a 75 VA transformer) typical sustained with fuseless shutdown at 2.5A
Bell Output	1A, fuseless shutdown at 3A	1A typical, fuseless shutdown at 3A
PGM Output	PGM1 to PGM4: 100 mA solid-state relays with +/- trigger PGM5: Form C relay output rated at 5A / 28 Vdc N.O. / N.C.	PGM1: Open collector output PGM2 to PGM4: 100 mA solid-state relays with +/- trigger PGM5: Form C relay output rated at 5A / 28 Vdc N.O. / N.C.
Operating Temperature	-10 to 55 °C (14 to 131 °F)	-10 to 55 °C (14 to 131 °F)
Metal Box	Fits in 28 x 28 x 7.6 cm (11 x 11 x 3 in.) metal box	Fits in 28 x 28 x 7.6 cm (11 x 11 x 3 in.) metal box
Dimensions	19 x 10.9 x 2.5 cm (7.5 x 4.3 x 1 in.)	20.2 x 9.6 x 4.4 cm (8 x 3.8 x 1.8 in.)

Certification / Special Feature



EVO Keypads Touchscreen



Optional frame colors

TM50 Wired Touchscreen Keypad

► Features

- Controls and displays up to 192 zones in 8 partitions
- Controls up to 8 PGM outputs
- Customizable labels (zones, partitions, users, and PGM outputs)
- Powerful advanced processor
- SpotOn Locator™ provides customizable graphic presentation of zone locations based on floor plans or photographs (store up to 32 floor plans, personalized floor plans and images)
- OneScreen Monitoring™ displays all partitions, all zones status reports
- Solo Test™ for easy testing of system's zones
- External SD Media Card Slot for firmware upgrades and uploading photos for slide show
- Multilingual display
- Quick change fashion color frames

► Specifications

Display	16-bit, color LCD; 6.4 x 11.2 cm (2.5 x 4.4 in.), 480 x 272 pixels
Input Voltage	9 to 16 Vdc
Current Consumption	200 mA maximum alarm
Keypad Zone Input	1 for a detector or external temperature sensor
Humidity	5 to 93%
Operating Temperature	-10 to 55 °C (14 to 131 °F)
Dimensions / Weight	14.4 x 9.6 x 1.4 cm (5.7 x 3.8 x 0.6 in.) / 165g (5.8 oz)

EVO Keypads LCD



K641+ Wired LCD Keypad

► Features

- Controls and displays up to 192 zones in 8 partitions
- 14 one-touch action buttons
- 3 keypad-activated panic alarms
- 32-character, blue LCD with programmable labels
- Zone alarm display: zones in alarm are shown until the system is disarmed
- Adjustable key backlight, contrast, and scroll speed
- Multilingual display
- In-field firmware upgradeable via 307USB and InField software
- Display time of 12 or 24 hour format

► Specifications

Input Voltage	9 to 16 Vdc
Current Consumption	150 mA maximum
PGM Output	1
Keypad Zone Input	1
Connections	4-wire communication bus
Operating Temperature	-10 to 55 °C (14 to 131 °F)
Dimensions	12.3 x 14.4 x 3.2 cm (4.9 x 5.7 x 1.3 in.)



K641LX Wired LCD Keypad with Integrated RF Transceiver

► Features

- Same features as the K641+ along with the following:
- RF transceiver

► Specifications

Same specifications as the K641+ except for the following:

RF Frequency	433 or 868 MHz
Current Consumption	Maximum current 120 mA
Operating Temperature	0 to 49 °C (32 to 120 °F)
Dimensions	15 x 8.5 x 2 cm (5.9 x 3.3 x 0.8 in.)

EVO Keypads LCD



K641R

Wired LCD Keypad with Integrated Access Card Reader

► Features

Same features as the K641+ along with the following:

- Built-in card reader; simply present access card directly to the keypad
- Arm and disarm with an access card or code
- Programmable automatic unlocking schedule
- Door Left Open and Door Forced Open alarms
- Door contact and request for exit inputs
- Door lock output

► Specifications

Same specifications as the K641+ except for the following:

Current Consumption	140 mA maximum
Operating Temperature	0 to 49 °C (32 to 120 °F)
Dimensions	12.3 x 14.4 x 3.2 cm (4.9 x 5.7 x 1.3 in.)



K656

Touch Sense LCD Keypad

► Features

Same features as the K641+ along with the following:

- Touch Sense keys with LED backlighting
- 5 one-touch action buttons

► Specifications

Same specifications as the K641+ except for the following:

Input Voltage	12 to 16 Vdc
Current Consumption	70 mA maximum
Dimensions	15 x 8.5 x 2.1 cm (5.9 x 3.3 x 0.8 in.)



EVO Motion Detectors

Indoor



DM50 / DM60

Motion Detector Module

► Features

- DM50: Dual element PIR sensor
DM60: Quad opposed element PIR sensors
- Auto-Pulse Signal Processing* (APSP)
- Anti-tamper switch
- 4-wire bus connection

► Specifications

Detection Range	12 x 12m (40 x 40 ft) at 110°
Input Voltage	9 to 16 Vdc
Current Consumption	Typical: 16 mA, Maximum: 30 mA
Operating Temperature	-20 to 50 °C (-4 to 122 °F)
Dimensions	6.6 x 9.3 x 5.2 cm (2.6 x 3.7 x 2 in.)

Top View

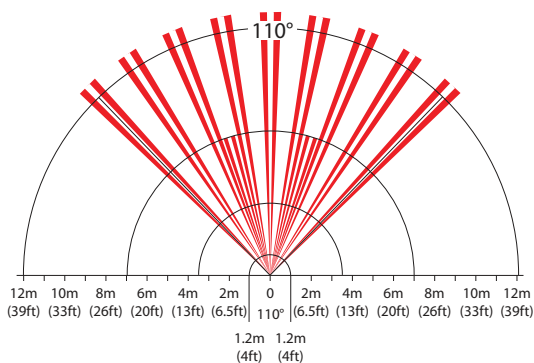

Side View

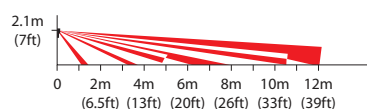

* Patented

EVO Motion Detectors

Indoor



DM70

High-Security Motion Detector Module with Pet Immunity

► Features

- 2 x dual opposed element PIR sensors
- Auto-Pulse Signal Processing* (APSP)
- Anti-tamper switch
- 4-wire bus connection

► Specifications

Detection Range	11 x 11m (35 x 35 ft) at 90°
Pet Immunity	Up to 40 kg (90 lb)
Input Voltage	9 to 16 Vdc
Current Consumption	Typical: 16 mA, Maximum: 30 mA
Operating Temperature	-20 to 50 °C (-4 to 122 °F)
Dimensions	6.5 x 12.6 x 5.5 cm (2.6 x 4.9 x 2.2 in.)

Top View

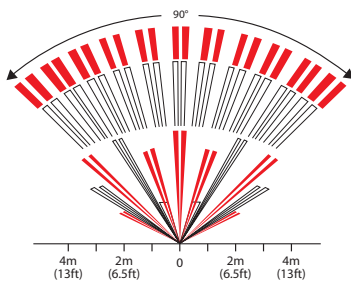

Side View

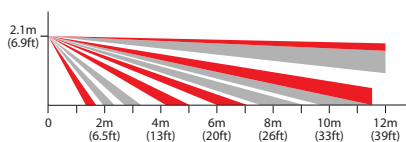

EVO Motion Detectors

Digital Ceiling

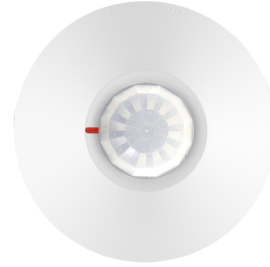

DG467

360° Ceiling-Mounted Digital Motion Detector

► Features

- Dual element PIR sensor
- Anti-tamper switch
- Auto-Pulse Signal Processing* (APSP)
- 4-wire bus connection

► Specifications

Detection Range	7 x 6m (24 x 20 ft) at 2.4m (8 ft); 11 x 6m (35 x 20 ft) at 3.7m (12 ft)
Input Voltage	9 to 16 Vdc
Current Consumption	Typical: 29 mA
Alarm Output Available	Form A relay, N.C.
Operating Temperature	-20 to 50 °C (-4 to 122 °F)
Dimensions	10.8 diameter x 13.5 cm depth (4.25 x 1.38 in.)

Top View

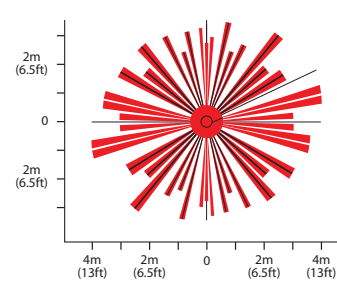

Side View

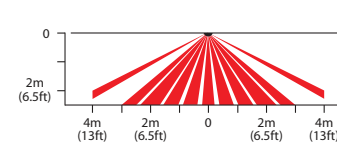

* Patented



* Patented

EVO Motion Detectors

Outdoor



NV35MX

Wired Outdoor / Indoor Window and Sliding Door Dual Detector

► Features

- Outdoor / indoor protection solution for windows and sliding doors
- Advanced Optical and Digital Technology
- Dual detectors, managed by Full Authority Digital Electronics Control (FADEC)
- Patented Auto Pulse Signal Processing with Automatic Temperature Compensation
- Digital EMI / RFI interference rejection
- Optical Pet discrimination geometry to support super Pet Immunity
- Anti-Masking: Unique active IR detection for both blocking items up to 30 cm in front of the detector and sprayed liquids
- Ultra low power management operation with Paradox Effi+ circuit
- Dual tamper detection (removal of cover or unit)

► Specifications

Detection Range	Super Pet Immunity Mode: 7.5 x 2m (25 x 7 ft) Sharp Mode (Pet Immunity off): 10 x 2m (33 x 7 ft)
Pet Immunity	50 cm (20 in.)
Input Voltage	10 to 15 Vdc
Current Consumption	Typical: 15 mA, Maximum: 19.2 mA
IP Rating	IP54
Operating Temperature	-35 to 60° C (-31 to 140° F)
Dimensions	12.3 x 6.1 x 4.3 cm (4.8 x 2.4 x 1.7 in.)

Top View

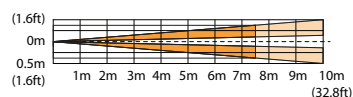

Side View (Pet Immunity Mode)

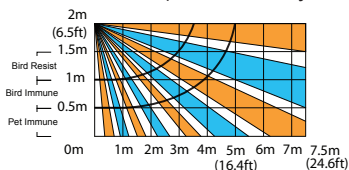

Side View (Sharp Mode Use Only)

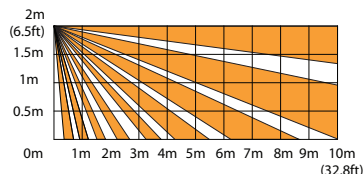

EVO Motion Detectors

New!



NV780MX

Dual Side-View Outdoor Detectors with Anti-Masking and Pet Immunity

► Features

- Dual side anti-masking detection – Active IR detection, fast 20 seconds detection designed for outdoor detection of sprayed liquids and blocking items up to 25 cm (10 in.)
- 4 dual element sensors arrangement
- Combination optics – mirror and Fresnel Lens for optimal sharp detection
- Single or Dual operation modes
- Optical and digital range adjustments
- Dual LED and buzzer indicators
- Wall-mount with built-in level tool

► Specifications

Detection Range	2 x 3m to 12m (9.8 to 39 ft) at 2.5m height
Pet Immunity	Up to 40 kg (90 lb)
Input Voltage	9 to 15 Vdc
Current Consumption	Typical / Standby: 37 mA, Maximum: 80 mA
Operating Temperature	-35 to 50°C (-31 to 122°F)
Dimensions	21 x 11 x 7 cm (8.2 x 4.3 x 2.7 in.)

Wall (Top View)

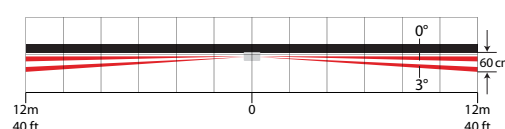

Range Adjustment

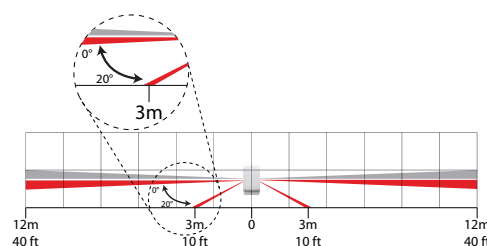

EVO Motion Detectors

Outdoor



DG85

Outdoor Digital Motion Detector with Pet Immunity

Features

- ▶ 2 x Dual-Opposed element PIR sensors
- ▶ Increased white light rejection
- ▶ Anti-tamper switch
- ▶ Available with 1 of 3 lenses: Pet Array, Horizontal Curtain Beam, or Vertical Curtain Beam lens
- ▶ Impact and temperature resistant casing, with UV protected lens
- ▶ Multi-Level sensitivity adjustment
- ▶ Can be used with SB85 Heavy Duty Outdoor Swivel Bracket

Specifications

Detection Range	11 x 11m (36 x 36 ft); 90° - Pet Array
Pet Immunity	Up to 40 kg (90 lb)
Input Voltage	9 to 16 Vdc
Current Consumption	Typical: 30 mA Maximum: 40 mA
Alarm Output Available	Form A relay, N.C.
IP Rating	IPX4
Operating Temperature	-35 to 50 °C (-31 to 122 °F)
Dimensions	7.9 x 17.5 x 6.6 cm (3.1 x 6.9 x 2.6 in.)

Pet Array

Top View

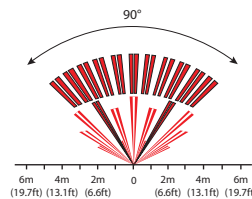

Side View

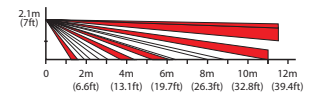

Horizontal Curtain Beam

Top View

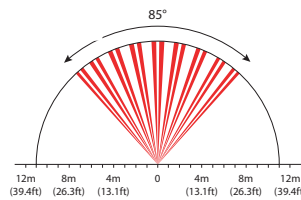

Side View

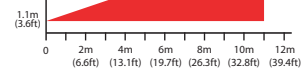

Vertical Curtain Beam

Top View

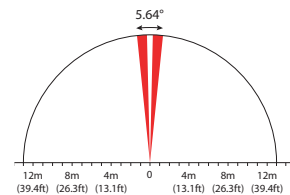

Side View

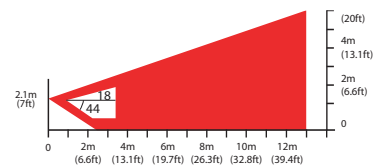

EVO Motion Detectors

Outdoor



NVX80

Powerful Motion Detector with MW Anti-Mask and SeeTrue™ Technology for Outdoor / Indoor Use

► Features

- ▶ 8 detection channels including 2 x Quad forward looking PIR channels, 2 x 10.5 GHz MW channels and 1 x Quad standalone creep detector
- ▶ Paradox Active IR and MW Anti-Mask* recognizes lens degradation and objects blocking the main lens within 30 cm of the detector
- ▶ Built-in color OLED display, with 4-button interface, enables easy signaling configuration and maintenance without opening the unit
- ▶ 3 relay outputs enable maximum flexibility and compatibility with other security systems
- ▶ EVO interface with remote programming capability using EVO bus
- ▶ Multi-level detection sensitivity adjustment
- ▶ Dual-tamper mechanism (wall / cover)
- ▶ Can be used with a bracket
- ▶ Can be used with RC80 Rain Cover (included)

► Specifications

Detection Range	17 x 15m (56 x 49 ft); 90° with Creep detection
Pet Immunity**	Recognizes animals up to 20 kg (44 lb)
Input Voltage	9 to 16 Vdc
Current Consumption	Typical: 75 mA, Maximum: 100 mA
Alarm Output Available	Form C N.O. / N.C., 2 x Form A N.O. or N.C. (selectable)
IP Rating	IP55
Operating Temperature	-35 to 60 °C (-31 to 140 °F)
Dimensions	9.8 x 22.9 x 9.2 cm (3.8 x 9.0 x 3.6 in.)

Top View

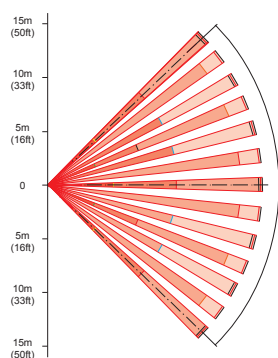

Side View

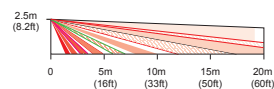

Top View (Creep Zone)

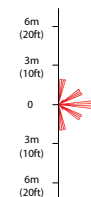

Side View (Creep Zone)

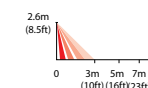

CE EN 50131 GRADE 3 EN 50130-5 CLASS IV EN 45011 SYSTEM 6 * Patent Pending ** Patented

EVO Wired Perimeter Detectors

Glass Break Bus Detector



DG457

Glass Break Detector

► Features

- ▶ Breakage in panes of glass 40.6 x 61 cm (16 x 24 in.) or larger are detected
- ▶ Effective coverage of plate, tempered, and laminated glass without the need for complicated sensitivity adjustments
- ▶ Two operational modes: EVO bus or conventional relay operation
- ▶ Anti-tamper switch
- ▶ Full audio and infrasonic spectrum analysis
- ▶ 7 frequency digital filters, digital amplifier gain, and frequency fluctuation assessment
- ▶ Impact and shock wave analysis
- ▶ High-immunity to RFI and EMI signals

► Specifications

Detection Range	Adjustable between 1.2 to 9m (4 to 29.5 ft) depending on environment and sensitivity settings
Input Voltage	9 to 16 Vdc
Current Consumption	35 mA
Alarm Output Available	Form A (N.C.) or via bus
Sensitivity Adjustment	Covers up to 9m (30 ft) when set to high, and up to 4.5m (15 ft) when set to low
Operating Temperature	-20 to 50 °C (-4 to 122 °F)
Dimensions	6.6 x 9 x 2.2 cm (2.6 x 3.6 x 0.9 in.)



EVO Magnetic Contact



ZC1

Door Contact Module to Protect Door and Windows

► Features

- 1 addressable zone
- On-board tamper switch
- LED module status display
 - Power-up Indication
 - Proper Operation
 - Locate Indication
 - Bus Fault Indication

► Specifications

Input Voltage	9 to 16 Vdc
Current Consumption	14.2 mA typical
Reed Switch	Form A, (SPST) reed switch
Operating Temperature	0 to 50 °C (32 to 122 °F)
Dimensions	Small size 7.4 x 2 x 3 cm (2.9 x 0.8 x 1.2 in.)

EVO Zone Expanders



ZX8

8-Zone Expansion Module

► Features

- 8 addressable zone inputs (16 with ATZ zone doubling feature)
- 1 PGM output (50 mA PGM)
- LED module status display
- Use zone input as an anti-tamper switch input
- Set a different input speed for each zone (up to 255 minutes), ideal for temperature monitoring applications
- Selectable EOL resistors values (version 6 or higher)

► Specifications

Input Voltage	12 to 16 Vdc
Current Consumption	28 mA maximum
PGM Current Limit	50 mA (ZX8SP / ZX8)
Humidity	95% maximum
Operating Temperature	-20° to 50° C (-4° to 122° F)
Dimensions	14 x 4.5 x 1.8 cm (5.5 x 1.8 x 0.7 in.)

EVO Zone Expanders



ZX4

4-Zone Expansion Module

► Features

- 4 addressable zone inputs (8 with ATZ zone doubling feature)
- Set a different input speed for each zone (up to 255 minutes), ideal for temperature monitoring applications
- Use zone input as an anti-tamper switch input

► Specifications

Input Voltage	11 to 16 Vdc
Current Consumption	28 mA maximum
Humidity	85% maximum
Operating Temperature	-20 to 50 °C (-4 to 122 °F)
Dimensions	7.5 x 4.7 x 1.8 cm (3 x 1.9 x 0.7 in.)



ZX1

1-Zone Expansion Module

► Features

- 1 addressable zone input (2 with ATZ zone doubling feature)
- Input speed: 15 ms - 255 minutes
- LED module status display

► Specifications

Input Voltage	9 to 16 Vdc
Current Consumption	28 mA maximum
Humidity	85% maximum
Operating Temperature	-20 to 50 °C (-4 to 122 °F)
Dimensions	8 x 4.7 x 2.3 cm (3.1 x 1.9 x 0.9 in.)

EVO Zone Expanders



ZX8D 8-Zone Expansion Module

► Features

- 8 addressable zone inputs
- LED zone status display
 - Zone LEDs turn on / off to identify assigned zone inputs
 - Verify correct wiring (no EOL, EOL without tamper, EOL with tamper)
 - Perform a walk test LED zone status display
- Set a different input speed for each zone (up to 255 minutes), ideal for temperature monitoring applications
- Connects to EVO bus: 4-wire encrypted 13.8 VDC communication bus
- All programming is done through BabyWare PC software and via an EVO keypad
- 35 mm DIN rail enclosure with removable terminals for fast, secure, orderly and economical installation

► Specifications

Input Voltage	12 to 16 Vdc
Current Consumption	60 mA
Operating Temperature	-20 to 50 °C (-4 to 122 °F)
Dimensions	11 x 10 x 6 cm (4.2 x 4 x 2.5 in.)



ZX16D 16-Zone Expansion Module

► Features

- 16 addressable zone inputs
- LED zone status display
 - Zone LEDs turn on / off to identify assigned zone inputs
 - Verify correct wiring (no EOL, EOL without tamper, EOL with tamper)
- Set a different input speed for each zone (up to 255 minutes), ideal for temperature monitoring applications
- Includes labels to identify each output
- 35 mm DIN rail enclosure with removable terminals for fast, secure, orderly and economical installation
- In-field firmware upgradeable

► Specifications

Input Voltage	12 to 16 Vdc
Current Consumption	68 mA
Operating Temperature	-20 to 50 °C (-4 to 122 °F)
Dimensions	10.7 x 10.5 x 7 cm (4.2 x 4.1 x 2.8 in.)



ZX32D 32-Zone Expansion Module / 2 Amp Bus Power Supply

► Features

- 32 addressable zone inputs
- LED zone status display
 - Zone LEDs turn on / off to identify assigned zone inputs
 - Verify correct wiring (no EOL, EOL without tamper, EOL with tamper)
- 6-LED module status display
- Includes labels to identify each zone / input
- Transformer sharing: modules can share a central AC supply (16-24 Vac) or DC supply (24 Vdc)
- Set a different input speed for each zone (up to 255 minutes), ideal for temperature monitoring applications
- Auxiliary outputs providing up to 700 mA with fuseless, shutdown at 1.1A
- On-board button to manually activate or deactivate the auxiliary output
- Fully supervised (AC, battery, low battery and auxiliary limit)
- Selectable battery charge current (350 or 850 mA)
- 35 mm DIN rail enclosure with removable terminals for fast, secure, orderly and economic installations
- Test Mode tests each input

► Specifications

Input Voltage	16 to 24 Vac or 24 Vdc
Internal Power Supply	Built-in 2.85A
Current Consumption	154 mA maximum
Module Rating	13.8 Vdc Class 2
Auxiliary Output	12 Vdc, 1A maximum
Battery	12 Vdc; 4 Ah or 7 Ah
Operating Temperature	-20 to 50 °C (-4 to 122 °F)
Dimensions	21 x 10 x 6 cm (8.4 x 4 x 2.5 in.)

EVO Zone Expanders



RTX3

Wireless Expansion Module

► Features

- 32 wireless addressable zones
- Maximum number of remote controls: 999 with EVO (32 with SP)
- Remote control compatibility:
 - REM1, REM2, REM3, REM15, REM101, RAC1, and RAC2 remote controls
- Supports wireless PGMs (8 with EVO, 16 with SP Series only)
- Supports SR150 and SR130 Wireless Sirens (SP Series only)
- Supports all MAGELLAN transmitters including 2WPGM
- Supports 2 RPT1 and 8 K32RF / K37 (SP Series only)
- RF jamming supervision
- Low battery, tamper and check-in supervision for reconnected modules
- Transmitter signal strength display
- 3 PGM outputs and 1 optional output
 - PGM outputs: PGM1 and PGM2 - 150mA PGM transistor outputs
 - PGM3 and PGM4 - form C relay output rated at 5A / 28Vdc, N.O. / N.C. (PGM4 optional)
- In-field firmware upgradeable via 307USB

► Specifications

Input Voltage	9 to 16 Vdc
Current Consumption	50 mA
RF Frequency	433 or 868 MHz
Sensitivity	-120 dBm
Humidity	5 to 90%
Operating Temperature	0 to 49 °C (32 to 120 °F)
Dimensions	15 x 16 x 3 cm (6 x 6.5 x 1.1 in.)

EVO Access Control

Control Module



ACM12

4-Wire Access Control Module

► Features

- Full Off-Line functionality
- Fast x10 access processing of up to 999 users
- In / out access control via two readers or reader and REX
- Access with card / pin or both
- Arm / disarm function with card / pin or both
- RS485 reader connection up to 300m / 1000 ft
- Force door, door left open detection / alarm
- Firmware upgradeable
- Easy, minimum fast programming
- 4 (total of 8 periods) unlock schedules
- Manual Door Unlock
- Unlock door on Fire Alarm

► Specifications

Input Voltage	16 Vac, 20 / 40 VA, 50-60 Hz
Auxiliary Output	12 Vdc, typical 600 mA, 1A fuseless shutdown
Battery	12 Vdc, 4 Ah minimum
Metal Box	Fits in a 20 x 25.5 x 7.6 cm (8 x 10 x 3 in.) metal box
Dimensions	14 x 9.2 x 2.5 cm (5.5 x 3.6 x 1 in.)



EVO Access Control

Card Reader & Keypad



R915

4-Wire Sealed Indoor / Outdoor Proximity Reader and Keypad

► Features

- Only 4 wires (instead of 7) to connect with 4-wire access control modules
- Adjustable red / green LED intensity and buzzer frequency
- Extreme weather-resistant design (injected rubber gasket and PCB cover)
- Available in 3 colors: white, silver, or black

► Specifications

Same specifications as the R910 (see below), except for the following:

Current Consumption	60 mA
Frequency	Exciter field at 125 kHz Pulse Modulated
IP Rating	IP65
Dimensions	14.4 x 15.2 x 2.5 cm (1.7 x 6 x 1 in.)



EVO Access Control Proximity Card Reader



R910 4-Wire Indoor / Outdoor Proximity Reader

► Features

- Only 4 wires (instead of 7) to connect with 4-wire access control modules
- Adjustable red / green LED intensity and buzzer frequency
- Extreme weather-resistant design
- Tricolor LED display
- Also available: 910WP gang plate covers
- In-field firmware upgradeable via CV4USB and BabyWare

► Specifications

Input Voltage	11 to 14.5 Vdc
Current Consumption	Typical: 100 mA With Card: 115 mA maximum
Frequency	Exciter field at 125 kHz Pulse Modulated
Operating Temperature	-35 to 65 °C (-31 to 149 °F)
Dimensions	5.5 x 15 x 2.5 cm (2.2 x 5.9 x 1 in.)



EVO Access Control Remote Controls with Integrated Access Card



RAC1 Remote Control with Integrated Access Card

► Features

- Performs up to 5 different system actions
- Built-in access card; present remote control to a reader like an access card
- Water resistant, clear blue plastic with backlight for buttons

► Specifications

RF Frequency	433 or 868 MHz
Battery Type	3V lithium battery (CR2032)
Wireless Range	Typical residential environment 60m (200 ft) with RTX3 (EVO) 30m (100 ft) with MG6250 45m (150 ft) with MG5000 / MG5050
Operating Temperature	0 to 50 °C (32 to 120 °F)
Humidity	5 to 90%
Dimensions / Weight	6 x 4.3 x 2 cm (2.3 x 1.7 x 0.8 in.) / 30g (1.06 oz)

EVO Access Control Proximity Cards



C702 Standard Proximity Card

► Features

- Convenient credit card size
- Super-thin and flexible
- Durable PVC housing (white)
- Passive (no battery required)
- Dimensions: 8.6 x 5.4 x 0.2 cm (3.4 x 2.1 x 0.08 in.)

► Feature specific to C702

- Vertical slot for clip attachment

► Features specific to C706

- Can have vertical or horizontal punch slot
- Suitable for dye-sublimation printing of images, photos, and text

C706 2-Sided High-Gloss ISO Proximity Card

EVO Access Control Proximity Key Tags



C704 Blue Proximity Key Tag

► Features

- Attaches conveniently to a key ring
- Durable clear blue plastic housing
- Passive (no battery required)
- Dimensions: 3.5 x 3.8 x 0.5 cm (1.4 x 1.5 x 0.5 in.)

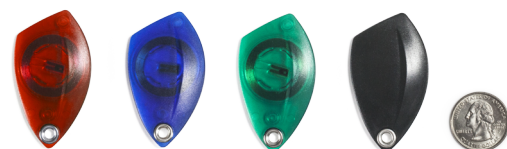

C705 Translucent Proximity Key Tag

► Features

Same features as the C704 along with the following:

- Available in a variety of colors: Blue, Red, Green and Black
- Dimensions: 3.2 x 5.6 x 0.8 cm (1.3 x 2.2 x 0.3 in.)

EVO Special Modules

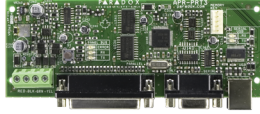

PRT3

Integration / Printer Module

► Features

- Provides the ability to automatically print live or stored events
- Provides an interface between an EVO control panel and a third-party peripheral system
- Supports ASCII / C-BUS protocols
- 16 virtual inputs to trigger an action in the EVO control panel based on an event received from the peripheral system, using ASCII or C-BUS protocol
- 30 virtual PGMs to trigger an action in the peripheral system based on an event received from the EVO control panel, using ASCII or C-BUS protocol
- USB port for PC connections
- Parallel and serial port for printer connections
- 2,048 event buffer
- Automatically / manually prints reports of zone / system events via printer or PC
- Available in multiple languages
- In-field firmware upgradeable via a CV4USB

► Specifications

Input Voltage	9 to 16 Vdc
Current Consumption	60 mA maximum
Parallel Port	Minimum 80 column printer
Serial Port	1 start bit, 8 data bit, no parity and 1 stop bit (8N1)
Serial Port Baud Rates	2400, 9600, 19200 or 57600 bps
Dimensions	14 x 6 x 2.5 cm (5.5 x 2.4 x 1 in.)



PS17

Power Supply Module

► Features

- 1.7A switching power supply
- Fully supervised (AC, battery, low battery and auxiliary limit)
- Selectable battery charge current (350mA / 850mA)

► Specifications

AC Power Input	16 Vac 20 / 40 VA, 50-60 Hz
Auxiliary Output	12 Vdc 600 mA typical, 700 mA maximum
Battery	12 Vdc Minimum: 4 Ah (Lead Acid or Gel Cell)
Number of Outputs	1 form C relay rated at 125V, 5A resistive load
Humidity Control Panel	85%
Dimensions	14 x 7.5 x 3 cm (5.5 x 3 x 1.2 in.)



HUB2

2-Port Hub and Bus Isolator

► Features

- Divides the communication bus into two, completely isolated branches
 - 1 input port, 2 isolated output ports
 - Each output port provides communication to modules at a distance of up to 900m (3000 ft)

► Specifications

Input Voltage	12 to 16 Vdc
Current Consumption	Typically: 24 mA Maximum: 50 mA
Distance from Panel	EVO: 18 AWG = 914m (3000 ft) or 22 AWG = 305m (1000 ft) MGSP: 18 AWG or 22 AWG = 76m (250 ft)
Distance of each output	EVO: 18 AWG = 914m (3000 ft) or 22 AWG = 305 (1000 ft) MGSP: 18 AWG or 22 AWG = 76m (250 ft)
Operating Temperature	0 to 55 °C (-4 to 122 °F)
Dimensions	14 x 4.5 x 1.8 cm (5.5 x 1.8 x 0.7 in.)



ANSI/SIA CP-01-2010



PGM4

4-Output Expansion Module

► Features

- 4 programmable, 5A relay outputs
- Activate / Deactivate PGM after event and / or timer
- Pulse PGM output for fire alarms
- In-field firmware upgradeable via a CV4USB or 307USB

► Specifications

Input Voltage	11 to 16 Vdc
Current Consumption	Typical 13 mA, 150 mA maximum (all PGMs active)
Number of Outputs	4 form C relays rated at 125V, 5A resistive load
Humidity	95% maximum
Dimensions	14 x 4.5 x 3 cm (5.5 x 1.8 x 1.2 in.)



SPECTRA combines innovative features with an advanced communication bus for a unique expandable security system. Through its communication bus, SPECTRA can be expanded via wireless and wired expansion modules and a variety of accessory modules. With its reliable communication technology, flexible expansion and great-looking keypads, SPECTRA is an ideal security system for any residential or commercial installation that requires up to 32 zones of protection.

The SPECTRA SP series' outstanding reliability easily expands to provide you with more features, such as StayD™, more on-board zones (expandable up to 32), more on-board PGMs (expandable up to 16), and support for the GSM / GPRS Modules (PCS Series), Plug-In Voice Dialer (VDMP3) and Internet Module (IP150). With their in-field firmware upgrade capability, the SPECTRA SP series allows installers to upgrade their system without hassle - quickly, easily and on site. And to further simplify installation, every SPECTRA panel can be configured using easy-to-follow program menus.

SPECTRA
Compatibility Overview

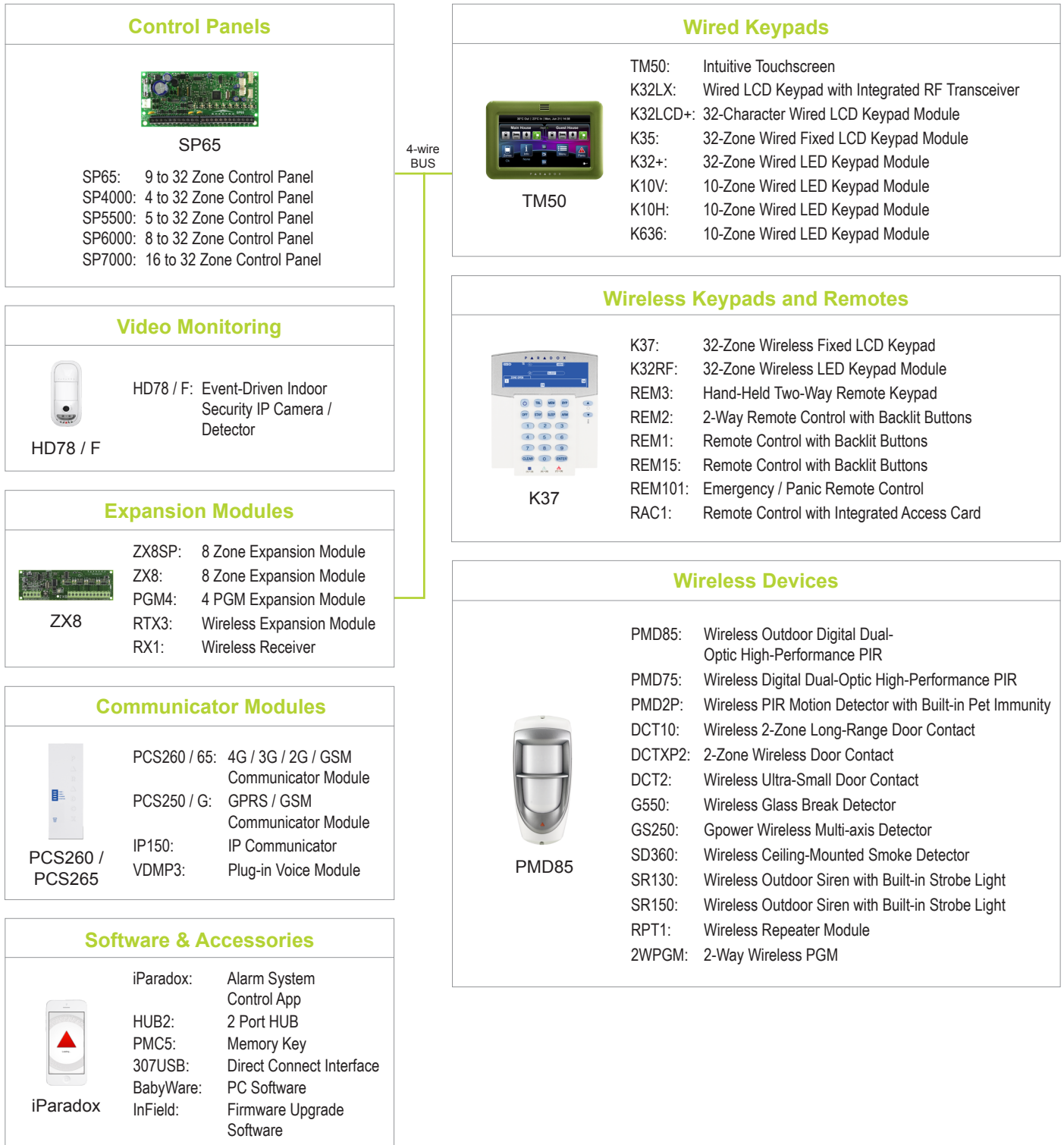

SPECTRA







Control Panels Comparison



Features

	SP4000	SP5500
StayD™	▲	▲
Maximum Zones*	32	32
On-board Zones	4 (8 with ATZ)	5 (10 with ATZ)
Expansion Zones	24	24
Keypad Zones	15	15
Partitions	2	2
User Codes	32	32
PGMs	12 (1 on-board)	16* (2 on-board)
PGM +/- Trigger	-	-
Siren	Wired	Wired / Wireless with RTX3
Alarm Relay	-	-
Event Buffer	256	256
Wireless Expansion	▲	▲
2-Wire Smoke Detector Input	-	-
GPRS / GSM Module (PCS Series)	▲	▲
Compatible with IP150	▲	▲
Compatible with VDMP3	▲	▲
Patented 2 Opto Coupler Dialer Circuit	▲	▲
In-Field Firmware Upgradeable	▲	▲

Specifications

Input Voltage	16.5 Vac (50 or 60 Hz) minimum 20 VA (40 VA recommended)	16.5 Vac (50 or 60 Hz) minimum 20 VA (40 VA recommended)
Internal Power Supply	1.1A switching	1.1A switching
Battery	12 Vdc, 4 Ah / 7 Ah	12 Vdc, 4 Ah / 7 Ah
Battery Charging Current	Limited by 1.1A supply current (AUX consumption - no dedicated battery current limit circuit)	350 mA or 700 mA
Auxiliary Current	450 mA, fuseless shutdown at 600 mA	700 mA maximum, fuseless shutdown at 1.1A
Bell Output	1A (fuseless shutdown at 3A)	1A (fuseless shutdown at 3A)
PGM Output	1 x 100 mA open collector	2 x 100 mA solid state
Operating Temperature	-10 to 55 °C (14 to 131 °F)	-10 to 55 °C (14 to 131 °F)
Metal Box	Fits in 20 x 25.5 x 7.6 cm (8 x 10 x 3 in.) and 28 x 28 x 7.6 cm (11 x 11 x 3 in.) metal boxes	Fits in 20 x 25.5 x 7.6 cm (8 x 10 x 3 in.) and 28 x 28 x 7.6 cm (11 x 11 x 3 in.) metal boxes
Dimensions	6.6 x 14 x 2.5 cm (2.5 x 5.5 x 1 in.)	8.9 x 19 x 2.5 cm (3.5 x 7.5 x 1 in.)
Special Feature Certification	 	    

▲ = included feature

*any of which can be wireless **optional

SPECTRA

Control Panels Comparison



Features

	SP6000	SP65	SP7000
StayD™	▲	▲	▲
Maximum Zones*	32	32	32
On-board Zones	8 (16 with ATZ)	9 (18 with ATZ)	16 (32 with ATZ)
Expansion Zones	24	24	16
Keypad Zones	15	15	15
Partitions	2	2	2
User Codes	32	32	32
PGMs	16* (2+2** on-board)	16* (3 on-board)	16* (4 on-board)
PGM +/- Trigger	▲	▲ (via BabyWare)	▲
Siren	Wired / Wireless with RTX3	Wired / Wireless with RTX3	Wired / Wireless with RTX3
Alarm Relay	1**	-	1
Event Buffer	256	256	256
Wireless Expansion	▲	▲	▲
2-Wire Smoke Detector Input	▲	-	▲
GPRS / GSM Module (Series)	▲	▲	▲
Compatible with IP150	▲	▲	▲
Compatible with VDMP3	▲	▲ (via PCS250)	▲
Patented 2 Opto Coupler Dialer Circuit	▲	-	▲
In-Field Firmware Upgradeable	▲	▲	▲

Specifications

Power Supply	1.5A switching	1.5A switching	1.5A switching
Input Voltage	16.5 Vac (50 or 60 Hz) minimum 20 VA (40VA recommended)	16.5 Vac (50 or 60 Hz) minimum 20 VA (40 VA recommended)	16.5 Vac (50 or 60 Hz) minimum 20 VA (40 VA recommended)
Battery	12 Vdc, 4Ah / 7Ah	12 Vdc, 4Ah / 7Ah	12 Vdc, 4Ah / 7Ah
Battery Charging Current	350 or 700 mA	Limited by 1.1A supply current (AUX consumption - no dedicated battery current limit circuit)	350 or 700 mA
Auxiliary Current	700 mA maximum, fuseless shutdown at 1.1A	700 mA maximum, fuseless shutdown at 1.1A	700 mA maximum, fuseless shutdown at 1.1A
Bell Output	1A (fuseless shutdown at 3A)	1A (fuseless shutdown at 3A)	1A (fuseless shutdown at 3A)
PGM Output	2 x 100 mA solid state and 2 x 100 mA open collector (+/- trigger)	3 on-board PGMs (all +/- trigger)	2 x 100 mA open collector and 2 x 100 mA solid state (+/- trigger)
Operating Temperature	-10 to 55 °C (14 to 131 °F)	0 to 50 °C (32 to 122 °F)	0 to 50 °C (32 to 122 °F)
Metal Box	Fits in 20 x 25.5 x 7.6 cm (8 x 10 x 3 in.) and 28 x 28 x 7.6 cm (11 x 11 x 3 in.) metal boxes	Fits in 20 x 25.5 x 7.6 cm (8 x 10 x 3 in.) and 28 x 28 x 7.6 cm (11 x 11 x 3 in.) metal boxes	Fits in 20 x 25.5 x 7.6 cm (8 x 10 x 3 in.) and 28 x 28 x 7.6 cm (11 x 11 x 3 in.) metal boxes
Dimensions	8.9 x 19 x 2.5 cm (3.5 x 7.5 x 1 in.)	6.6 x 14 x 2.5 cm (2.6 x 5.5 x 1 in.)	10.8 x 20.3 x 2.5 cm (4.3 x 8 x 1 in.)
Special Feature Certification	 		

▲ = included feature

*any of which can be wireless **optional

SPECTRA Keypads

Touchscreen



Optional frame colors

TM50

Wired Touchscreen Keypad

► Features

- Controls and displays up to 32 zones in 2 partitions
- Controls up to 8 PGM outputs
- Customizable labels (zones, partitions, users, and PGM outputs)
- Powerful advanced processor
- SpotOn Locator™ provides customizable graphic presentation of zone locations based on floor plans or photographs (store up to 32 floor plans personalized floor plans and images)
- OneScreen Monitoring™ displays all partitions, all zones status reports
- Solo Test™ for easy testing of system's zones
- External SD Media Card Slot for firmware upgrades and uploading photos for slide show
- Multilingual display
- Quick change fashion color frames

► Specifications

Display	16-bit, color LCD; 6.4 x 11.2 cm (2.5 x 4.4 in.), 480 x 272 pixels
Input Voltage	9 to 16 Vdc
Current Consumption	Alarm: 200 mA
Keypad Zone Input	1 for a detector or external temperature sensor (TEMP07)
Humidity	5 to 93%
Operating Temperature	-10 to 55 °C (14 to 131 °F)
Dimensions / Weight	14.4 x 9.6 x 1.4 cm (5.7 x 3.8 x 0.6 in.) / 165g (5.8 oz)

SPECTRA Keypads

LCD



K32LX

Wired LCD Keypad with Integrated RF Transceiver

► Features

- Controls and displays up to 32 zones in 2 partitions
- 8 one-touch action buttons
- 3 keypad-activated panic alarms
- Provides access point for wireless transmitters
- 32-character, blue LCD with programmable labels
- StayD™ status LED
- Independently-set chime zones
- Adjustable key backlight, contrast, and scroll speed
- Multilingual display
- In-field firmware upgradeable via 307USB

► Specifications

Input Voltage	12 to 14 Vdc
RF Frequency	433 or 868 MHz
Current Consumption	Typical: 70 mA Maximum: 120 mA
Wireless Range	Typical residential environment 40m (130 ft)
PGM Output	1 (follows arm status)
Keypad Zone Input	1
Operating Temperature:	0 to 50 °C (32 to 122 °F)
Dimensions	12.3 x 14.4 x 3.2 cm (4.9 x 5.7 x 1.3 in.)

SPECTRA Keypads LCD



K32LCD+ Wired LCD Keypad

► Features

- Controls and displays up to 32 zones in 2 partitions
- 8 one-touch action buttons
- 3 keypad-activated panic alarms
- 32-character, blue LCD with programmable labels
- Menu-driven programming for easy system setup (installer and end-user)
- StayD™ status LED
- Independently-set chime zones
- Separate Arm, Sleep, Stay, and Off LEDs per partition
- Adjustable key backlight, contrast and scroll speed
- Multilingual display
- In-field firmware upgradeable via 307USB

► Specifications

Input Voltage	12 to 14 Vdc
Current Consumption	Typical: 43mA Maximum: 86mA
Keypad Zone Input	1
Connections	4-wire expansion bus
Operating Temperature	-10 to 55 °C (14 to 131 °F)
Dimensions	12.6 x 15 x 2.7 cm (5 x 5.9 x 1.1 in.)



K35 Wired Fixed LCD Keypad

► Features

- Controls and displays the status of 32 zones in 2 partitions
- 8 one-touch action buttons
- 3 keypad-activated panic alarms
- Fixed message display that guides you in the operation of the system
- StayD™ status icon
- Displays Arm, Sleep, Stay and Disarmed status for each partition
- Displays troubles, bypassed zones and alarm memory
- Adjustable backlight
- Independently set chime zones
- Available in multiple languages
- In-field firmware upgradeable via 307USB

► Specifications

Input Voltage	12 to 14 Vdc
Current Consumption	Typical: 38mA Maximum: 103mA
Keypad Zone Input	1
Connections	4-wire expansion bus
Operating Temperature	0 to 50 °C (32 to 122 °F)
Dimensions	12.3 x 14.4 x 3.2 cm (4.9 x 5.7 x 1.3 in.)

SPECTRA Keypads LCD

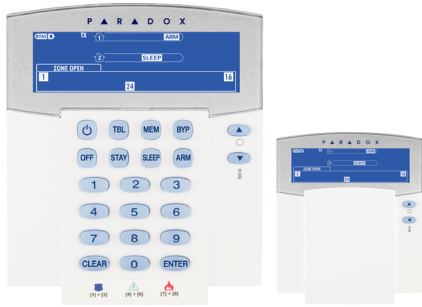

K37 Wireless Fixed LCD Keypad

► Features

- Controls and displays the status of 32 zones in 2 partitions
- 8 one-touch action buttons
- 3 keypad-activated panic alarms
- Fixed message display that guides you in the operation of the system
- StayD™ status icon
- Displays Arm, Sleep, Stay and Disarmed status for each partition
- Displays troubles, bypassed zones and alarm memory
- Goes into Standby Mode after 20 seconds to save battery life, but remains synchronized with the panel to automatically re-activate upon an entry delay or alarm
- Adjustable backlight
- Independently set chime zones
- Can be used with external 6VDC power adapter as an alternative power source (PA6 not included)
- Available in multiple languages
- In-field firmware upgradeable via 307USB

► Specifications

Input Voltage	Primary Power: 6 Vdc (300 mA) Backup Power: 2 x AA batteries
RF Frequency	433 or 868 MHz
Battery Life	Up to 1 year
Wireless Range	40m (130 ft) typical in residential environment
Operating Temperature	0 to 50 °C (32 to 122 °F)
Dimensions	12.3 x 14.4 x 3.2 cm (4.9 x 5.7 x 1.3 in.)

SPECTRA Keypads LED

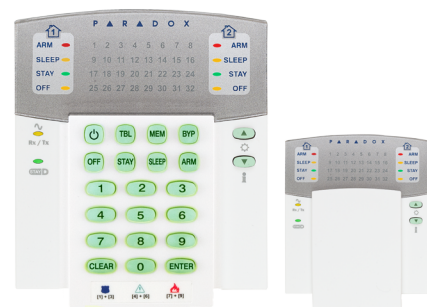

K32RF Wireless LED Keypad Module

► Features

- Controls and displays up to 32 zones and 2 partitions
- 8 one-touch action buttons
- 3 keypad-activated panic alarms
- StayD™ Status LED
- Separate Arm, Sleep, Stay, and Off LEDs per partition
- Adjustable key backlight
- Available in multiple languages
- In-field firmware upgradeable via 307USB

► Specifications

Input Voltage	Primary Power: 6 Vdc (300 mA) Backup Power: 3.7 Vdc Li-ion rechargeable
RF Frequency	433 or 868 MHz
Battery Life	Up to 48 hours
Wireless Range	40m (130 ft) typical in residential environment
Connections	4-wire expansion bus
Operating Temperature	0 to 50 °C (32 to 122 °F)
Dimensions	12.2 x 14.7 x 3.4 cm (4.8 x 5.8 x 1.3 in.)

SPECTRA Keypads

LED



K32+

Wired LED Keypad

► Features

- Controls and displays up to 32 zones in 2 partitions
- 7 one-touch action buttons
- 3 keypad-activated panic alarms
- StayD™ mode
- Independently-set chime zones
- Separate Arm, Sleep, Stay, and Off LEDs per partition
- Available in multiple languages
- In-field firmware upgradeable via 307USB

► Specifications

Input Voltage	12 to 14 Vdc
Current Consumption	Typical: 40mA Maximum: 150mA
Keypad Zone Input	1
Operating Temperature	-10 to 55 °C (14 to 131 °F)
Dimensions	12.6 x 15 x 2.7 cm (5 x 5.9 x 1.1 in.)

STAY D™



EN 50131
GRADE 2

EN 50130-5
CLASS II

EN 45011
SYSTEM 5



K636

Wired LED Keypad

► Features

- Controls and displays up to 10 zones; partition 1 only
- StayD™ Status LED
- Arm, Sleep, Stay and Off keys illuminate to indicate partition status
- Patented Key Light display (button lights up to indicate an open zone)
- Adjustable key backlight
- Available in multiple languages

► Specifications

Input Voltage	12 to 14 Vdc
Current Consumption	Minimum: 15mA Maximum: 30mA
PGM Output	1 (follows arm status)
Operating Temperature	0 to 50 °C (32 to 122 °F)
Dimensions	14.3 x 7.8 x 2.3 cm (5.6 x 3.1 x 0.9 in.)

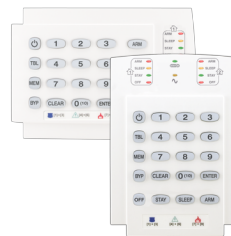

K10V / K10H

Wired LED Keypad

► Features

- Controls and displays up to 10 zones in 2 partitions
- 7 one-touch action buttons
- 3 keypad-activated panic alarms
- StayD™ mode
- 10-zone LED display
- LED displays for each partition: Arm, Sleep, Stay and Off
- Patented Key Light display (button lights up to indicate an open zone)
- Adjustable key backlight
- Connects to 4-wire communication bus
- Available in multiple languages

► Specifications

Input Voltage	12 to 14 Vdc
Current Consumption	Typical: 18mA Maximum: 73mA
Keypad Zone Input	1
Operating Temperature	-10 to 55 °C (14 to 131 °F)
Dimensions	K10H: 9.6 x 13.5 x 3.2 cm (3.8 x 5.3 x 1.3 in.) K10V: 13.5 x 9.6 x 3.2 cm (5.3 x 3.8 x 1.3 in.)

STAY D™



SPECTRA Zone Expanders



ZX8SP

8-Zone Expansion Module

► Features

- 8 zone inputs
- 1 PGM output (50 mA PGM)
- Uses zone input as an anti-tamper switch input

► Specifications

Input Voltage	12 to 16 Vdc
Current Consumption	28 mA
Operating Temperature	-20 to 50 °C (-4 to 122 °F)
Dimensions	14 x 4.5 x 1.8 cm (5.5 x 1.8 x 0.7 in.)



SPECTRA Zone Expanders



RX1 Wireless Receiver

► Features

- ▶ Controls up to 32 wireless zones
- ▶ Controls up to a maximum of 32 remote controls
- ▶ Compatible with remotes REM101, REM1, RAC1, and REM15
- ▶ Compatible with transmitters DCT10, DCTXP2, DCT2, PMD2P, PMD75, PMD85, SD360, NVR780, GS250, and G550
- ▶ RF jamming supervision
- ▶ Low battery, tamper, and check-in supervision for transmitters
- ▶ Transmitter signal strength display
- ▶ 2 PGM outputs
- ▶ In-field firmware upgradeable via 307USB

SPECTRA Special Modules

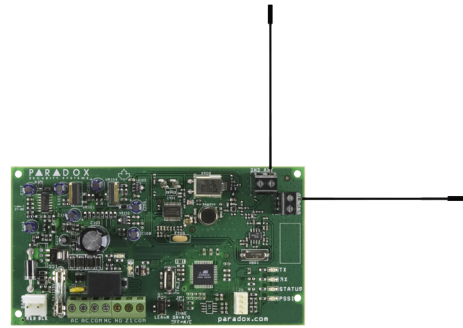

RPT1 Wireless Repeater Module

► Features

- ▶ Extends the range of wireless communications
- ▶ Built-in transceiver
- ▶ Supports all MAGELLAN transmitters (including two-way)
- ▶ Selects which zone, PGM and / or keypad signals are repeated
- ▶ Signal strength display
- ▶ RF jamming supervision
- ▶ Fully supervised by panel or console
- ▶ 1 programmable 5A relay output
- ▶ Universal input (N.O. / N.C.)
- ▶ In-field firmware upgradeable via 307USB

► Specification

Voltage Input	16 Vac, 20 VA minimum
Battery	Backup battery DC: 12 Vdc 5 Ah battery
RF Frequency	433 or 868 MHz
Current Consumption	65 mA
Wireless Range	Typical residential environment 75m (240 ft) with 433 MHz 50m (160 ft) with 868 MHz
Number of Outputs	1 PGM N.O. / N.C. 5A relay, 60 Vdc / 120 Vac maximum
Operating Temperature	0 to 50 °C (32 to 122 °F)
Metal Boxes	Fits in 20 x 25.5 x 7.6 cm (8 x 10 x 3 in.) and 28 x 28 x 7.6 cm (11 x 11 x 3 in.) metal boxes
Dimensions	32 x 14 cm (12.6 x 5.5 in.)

For full details on:



ZX8
8-Zone Expansion
Module
Refer to page 13



HUB2
2-Port Hub and
Bus Isolator
Refer to page 17



RTX3
Wireless Expansion Module
Refer to page 15

For full details on:



PGM4
4-Output Expansion Module
Refer to page 17

Our MAGELLAN two-way wireless security systems offers you a combination of security, wireless convenience, easy installation and attractive consumer features for any residential or small commercial installation.

With its in-field firmware upgrade capability, the MAGELLAN line allows installers to upgrade systems without hassle — quickly, easily and on site. And to further simplify installation, every MAGELLAN panel can be configured using easy-to-follow program menus.

MAGELLAN consoles are all-in-one wireless security systems that combine today's in-demand consumer features with ease of use, high security, and a great look.

MAGELLAN Compatibility Overview

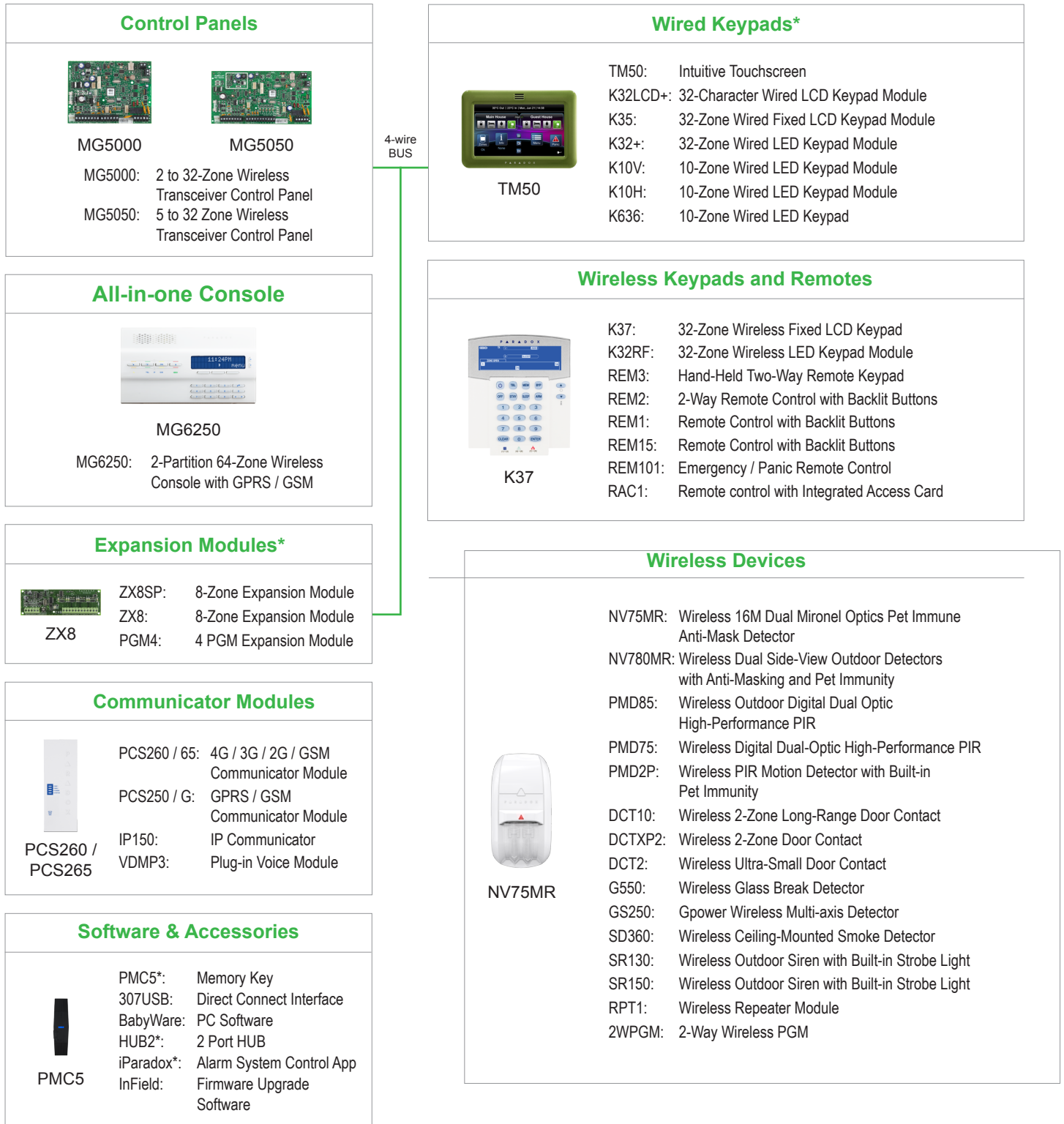

*non-applicable for the MG6250



Features

	MG5000	MG5050	MG6250 All-in-one Wireless Console with GPRS / GSM
Built-In Transceiver	▲	▲	▲
Supported Zones*	32, 2 on-board (4 with ATZ)	32, 5 on-board (10 with ATZ)	64, 2 on-board (I/O)
Keypad Zones	15	15	-
Partitions	2	2	2
Users / Remote Controls	32	32	16
PGMs	16* maximum (2 on-board)	16* maximum (4 on-board)	8* maximum (2 on-board I/O)
Events Buffered	256	256	256
Wireless Repeaters	2	2	4
Siren	Wired / Wireless	Wired / Wireless	Built-in 90 db siren / Wireless
Wireless Sirens	4 (SR130 / SR150)	4 (SR130 / SR150)	4 (SR130 / SR150)
Wireless Keypads	4 (K32RF / K37)	4 (K32RF / K37)	4 (K32RF / K37)
Expansion Bus	▲	▲	-
GPRS / GSM Module (PCS Series)	▲	▲	▲ (plug-in)
Internet Module (IP150)	▲	▲	-
Voice and Utility Reporting & User Menus	VDMP3	VDMP3	Built-in
Personal Dialing	▲	▲	▲
Two-Way Voice Communication	-	-	▲
In-Field Firmware Upgrade	▲	▲	▲
RF Jamming Supervision	▲	▲	▲

Consumer Features

Hands-free Speakerphone	-	-	▲
High-quality Voice and Sound	-	-	▲
Family Message Center	-	-	▲
Alarm Clock	-	-	▲

▲ = included feature

*any of which can be wireless

MAGELLAN

Control Panels Comparison

Specifications



	MG5000	MG5050	MG6250
Input Voltage	16.5 Vac (50 or 60 Hz) minimum 20 VA (40 VA recommended)	16.5 Vac (50 or 60 Hz) minimum 20 VA (40 VA recommended)	7.5 Vdc (PA7 Power Adapter Plug)
Auxiliary Current	700 mA maximum, fuseless shutdown at 1.1A	700 mA maximum, fuseless shutdown at 1.1A	-
RF Frequency	433 or 868 MHz	433 or 868 MHz	433 or 868 MHz
Battery	12 Vdc, 4Ah / 7Ah	12 Vdc, 4Ah / 7Ah	Pack: 4.8V NiMH, rechargeable
Battery Charging Current	350 mA or 700 mA	350 mA or 700 mA	-
PGM Output	2 x 100 mA open-collector	3 x 100 mA open-collector and 1 x 100 mA solid state	2 x 50 mA open-collector
Bell Output	1A (fuseless shutdown at 3A)	1A (fuseless shutdown at 3A)	-
Operating Temperature	0 to 50 °C (32 to 122 °F)	0 to 50 °C (32 to 122 °F)	0 to 40 °C (32 to 104 °F)
Metal Box	Fits in 20 x 25.5 x 7.6 cm (8 x 10 x 3 in.) and 28 x 28 x 7.6 cm (11 x 11 x 3 in.)	Fits in 20 x 25.5 x 7.6 cm (8 x 10 x 3 in.) and 28 x 28 x 7.6 cm (11 x 11 x 3 in.)	-
Dimensions	14 x 10.4 x 3 cm (5.5 x 4.1 x 1.2 in.)	19 x 10 x 3 cm (7.5 x 4 x 1.2 in.)	24.6 x 14 x 3.9 cm (9.7 x 5.5 x 1.5 in.)
Special Feature Certification		 	

For full details on:

<p>PGM4 4-Output Expansion Module Refer to page 17</p>	<p>K35 Wired Fixed LCD Keypad Refer to page 22</p>	<p>K636 Wired LED Keypad Refer to page 24</p>
<p>HUB2 2-Port Hub and Bus Isolator Refer to page 17</p>	<p>K32RF Wireless LED Keypad Module Refer to page 23</p>	<p>ZX8SP 8-Zone Expansion Module Refer to page 26</p>
<p>ZX8 8-Zone Expansion Module Refer to page 13</p>	<p>K37 Wireless Fixed LCD Keypad Refer to page 23</p>	<p>RPT1 Wireless Repeater Module Refer to page 24</p>
<p>TM50 Wired Touchscreen Keypad Refer to page 21</p>	<p>K10V / K10H Wired LED Keypad Refer to page 24</p>	
<p>K32LCD+ Wired LCD Keypad Refer to page 22</p>	<p>K32+ Wired LED Keypad Refer to page 24</p>	

MAGELLAN All-in-One Console Communicator Module

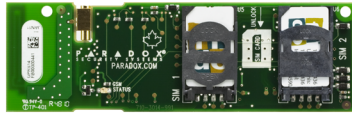

GPRS14 Plug-In Communicator Module

► Features

- Accessory for the MG6250, used to support GPRS / GSM / SMS reporting
- Supports 2 standard cellular provider SIM cards, for provider redundancy
- Simple installation; connects directly onto PCB
- Dimensions: 11 x 3.5 x 1.5 cm (4.3 x 1.4 x 0.6 in.)

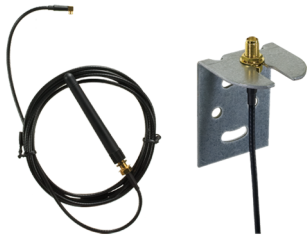

ANTKIT Antenna Extension for GPRS14

► Features

- Improves reception by extending the GPRS14 antenna
- Includes wall-mounting bracket
- Length: 2m / 6 ft

MAGELLAN Special Modules



2WPGM 2-Way Wireless PGM

► Features

- 1 programmable, 5A relay output
- Activation events
- Activates / Deactivates PGM after event or timer
- Backup Alarm Reporting option (activates PGM output if communication between the MAGELLAN console and the 2WPGM is lost)
- Built-in transceiver
- Universal input (N.O. / N.C.)
- Anti-tamper switch
- Can be powered by the PA12

► Specifications

Input Voltage	6 to 16.5 Vac or 5 to 20 Vdc
RF Frequency	433 or 868 MHz
Wireless Range	Typical residential environment 35m (115 ft) with MG6250 70m (230 ft) with MG5000 / MG5050 and RTX3
Operating Temperature	0 to 50 °C (32 to 122 °F)
Dimensions	12.5 x 4.6 x 2.5 cm (4.9 x 1.8 x 1.0 in.)



MAGELLAN Power Adapters



PA6 6 Vdc Power Adapter Plug

► Features

- For use with K32RF
- Provides 6 Vdc at 350 mA maximum
- Includes 1 of 5 different power outlets
- Dimensions: 4 x 8 x 7 cm (1.6 x 3.1 x 2.8 in.)



PA7 7.5 Vdc Power Adapter Plug

► Features

- For use with MG6250
- Provides 7.5 Vdc at 1A max
- Includes 1 of 5 different power outlets
- Dimensions: 4 x 8 x 7 cm (1.6 x 3.1 x 2.8 in.)



PA12 13.8 Vdc Power Adapter Plug

► Features

- For use with 2WPGM
- Provides 13.8 DC at 1A max
- Includes 1 of 5 different power outlets
- Dimensions: 4.3 x 7 x 5.1 cm (1.7 x 2.8 x 2 in.)

REMOTE CONTROLS

Specifications



	REM1	REM101	REM15	REM25	REM2	REM3
Description	4-Button Remote Control with Backlit Buttons	Emergency / Panic Remote Control	4-Button Remote Control with Backlit Buttons	2-Way Wireless Remote Control with Backlit Buttons	5-Button, 2-Way Remote Control with Backlit Buttons	Hand-Held 2-Way Remote Keypad
RF Frequency	433 or 868 MHz	433 or 868 MHz	433 or 868 MHz	433 or 868 MHz	433 or 868 MHz	433 or 868 MHz
Battery Type	1 x 3V lithium battery (CR2032)	1 x 3V lithium battery (CR2032)	1 x 3V lithium battery (CR2032)	1 x 3V lithium battery (CR2032)	1 x 3V lithium battery (CR2032)	1 x 3V lithium battery (CR2032)
Wireless Range for Typical Residential Environment	30m (100 ft) to 45m (150 ft)	30m (100 ft) to 45m (150 ft)	30m (100 ft) to 45m (150 ft)	30m (100 ft) to 45m (150 ft)	30m (100 ft) to 45m (150 ft)	30m (100 ft) to 45m (150 ft)
Humidity	5 to 90%	5 to 90%	5 to 90%	5 to 90%	5 to 90%	5 to 90%
Operating Temperature	-10 to 55 °C (14 to 131 °F)	-10 to 55 °C (14 to 131 °F)	-10 to 55 °C (14 to 131 °F)	-10 to 55 °C (14 to 131 °F)	-10 to 55 °C (14 to 131 °F)	0 to 50 °C (32 to 120 °F)
Dimensions / Weight	6 x 4.3 x 2 cm (2.3 x 1.7 x 0.8 in.) / 30g (1.05 oz)	5.1 x 3.2 x 1.3 cm (2.0 x 1.2 x 0.5 in.) / 16g (0.5 oz)	6.6 x 3.9 x 1.1 cm (2.6 x 1.5 x 0.4 in.) / 35g (1.2 oz)	3.9 x 7.2 x 1.2 cm (1.5 x 2.8 x 0.5 in.) / 40g (1.4 oz)	7.8 x 3.8 x 1.8 cm (3.1 x 1.5 x 0.7 in.) / 23.4g (0.82 oz)	8 x 3.4 x 1.4 cm (3.1 x 1.3 x 0.6 in.) / 32g (1.2 oz)
Special Features Certification						

MOTION DETECTORS - PIR

Wireless Indoor / Outdoor



	PMD2P	PMD75	NV75MR	PMD85	NV35MR	NV780MR
Page Reference	See page 33	See page 33	See page 34	See page 35	See page 35	See page 34
Indoor / Outdoor	Indoor	Indoor	Indoor	Outdoor	Indoor / Outdoor	Indoor / Outdoor
Sensor	Dual Element	2x Dual Element	2 x Dual Element	2x Dual Element	2x Dual Element	2x Dual Element
Detection Range	11 x 11m (36 x 36 ft);	11 x 11m (36 x 36 ft)	16m (52 ft)	11 x 11m (36 x 36 ft)	Pet: 7.5m x 2m (25 x 7 ft) Sharp: 10 x 2m (33 x 7 ft)	2 x 3m to 12m (9.8 to 39 ft)
Pet Immunity	Pet Tolerance up to 18 kg (40 lb)	Up to 40 kg (90 lb)	Up to 50 cm	Up to 40 kg (90 lb)	50 cm	Up to 40 kg (90 lb)
Digital Detection	-	▲	▲	▲	▲	▲
Auto Temperature Compensation	▲	▲	▲	▲	▲	▲
Dual Edge Processing	-	▲	▲	▲	-	-
Operating Temp.	0 to 50 °C (32 to 122 °F)	0 to 50 °C (32 to 122 °F)	-35 to 50° C (-31 to 122° F)	-35 to 50 °C (-31 to 122 °F)	-35 to 60° C (-31 to 140° F)	-35 to 60 °C (-31 to 140 °F)
Battery Type / Life	3xAAA, 2 years	3xAAA, 2 years	2xAA, 3 years	3xAA, 3 years	2xAA, 3 years	3xAA, 3 years
Certification						

▲ = included feature

Wired Indoor / Outdoor



	DG85	NV35M	NV780MX	NVX80
Page Reference	See page 11	See page 42	See page 10	See page 12
Indoor / Outdoor	Outdoor	Indoor / Outdoor	Indoor / Outdoor	Indoor / Outdoor
Sensor	2x Dual Element	2x Dual Element	4x Dual Element	8 Independent PIR Anti-Mask and Microwave sensors channels
Detection Range	11 x 11m (36 x 36 ft)	Pet: 7.5m x 2m (25 x 7 ft) Sharp: 10 x 2m (33 x 7 ft)	2 x 3m to 12m (9.8 to 39 ft)	17 x 15m (56 x 49 ft)
Pet Immunity	Up to 40 kg (90 lb)	50 cm	Up to 40 kg (90 lb)	Up to 20 kg (44 lb)
Digital Detection	▲	▲	▲	▲
Auto Temperature Compensation	▲	▲	▲	▲
Alarm Output	2x Solid State, N.C, 150 mA	2x Solid State, N.C, 150 mA	2x Solid State, N.C, 150 mA	Form C relay, N.C. and N.O., 1A 24 Vdc
Anti-Masking	-	▲	▲	▲
Dual Edge Processing	▲	-	-	▲
EVO Bus	▲	▲	▲	▲
Operating Temperature	-40 to 70 °C (-40 to 158 °F)	-35 to 60° C (-31 to 140° F)	-35 to 60 °C (-31 to 140 °F)	-25 to 70 °C (-13 to 158 °F)
Certification	 EN 50130-5 CLASS IV EN 50131 GRADE 2 EN 45011 SYSTEM 5	 EN 50131-6 CLASS IV EN 50131 GRADE 2	 EN 50130-5 CLASS II EN 50131 GRADE 2	 EN 50130-5 CLASS IV EN 50131 GRADE 3 EN 45011 SYSTEM 5

Wired Indoor



	NV75M	NV5	DG55+	DG65+	DG75+	DM50*	DM60*
Page Reference	See page 38	See page 41	See page 39	See page 39	See page 40	See page 08	See page 08
Sensor	2x Dual Element	Dual Element	Dual Element	Quad Element	2x Dual Element	Dual Element	Quad Element
Detection Range	16m (52 ft)	10m (32.8 ft)	12 x 12m (40 x 40 ft)	12 x 12m (40 x 40 ft)	11 x 11m (36 x 36 ft)	12 x 12m (40 x 40 ft)	12 x 12m (40 x 40 ft)
Pet Immunity	Up to 50 cm	Up to 16 kg (35 lb)	-	-	Up to 40 kg (90 lb)	-	-
Digital Detection	-	▲	▲	▲	▲	▲	▲
Auto Temperature Compensation	▲	▲	▲	▲	▲	▲	▲
Alarm Output	2x Solid State, N.C, 150 mA	2x Solid State, N.C, 150 mA	2x Solid State, N.C, 150 mA	2x Solid State, N.C, 150 mA	2x Solid State, N.C, 150 mA	EVO Bus	EVO Bus
Dual Edge Processing	▲	▲	▲	▲	▲	▲	▲
EVO Bus	-	-	-	-	-	▲	▲
Operating Temperature	-35 to 50° C (-31 to 122° F)	-10 to 50 °C (14 to 122 °F)	-20 to 50 °C (-4 to 122 °F)	-20 to 50 °C (-4 to 122 °F)	-20 to 50 °C (-4 to 122 °F)	-20 to 50 °C (-4 to 122 °F)	-20 to 50 °C (-4 to 122 °F)
Certification	 EN 50131 GRADE 3	 EN 50131 GRADE 2 EN 50130-5 CLASS II EN 45011 SYSTEM 5	 EN 50131 GRADE 2 EN 50130-5 CLASS I	 EN 50131 GRADE 2 EN 50130-5 CLASS I	 EN 50131 GRADE 2 EN 50130-5 CLASS II EN 45011 SYSTEM 5		

▲ = included feature

*Compatible only with EVO Control Panels

Wired Indoor



	DM70*	NV75MW	525DM	DG467	DG466	476	476PET	460
Page Reference	See page 09	See page 38	See page 40	See page 09	See page 42	See page 43	See page 43	See page 44
Sensor	2x Dual Element	2x Dual Element	1x MW, Dual Element	Dual Element	2x Dual Element	Dual Element	Dual Element	Dual Element
Detection Range	12 x 12m (40 x 40 ft)	11 x 11m (36 x 36 ft)	12 x 12m (40 x 40 ft)	7 x 6m (24 x 20 ft) at 2.4m / 11 x 6m (35 x 20 ft) at 3.7m	Curtain 4.8m (15.7 ft) directional	10.6 x 10.6m (35 x 35 ft)	11 x 11m (35 x 35 ft) and up to 15m (50 ft) for center beams	2.1 x 1.5 cm (7 x 5 ft) - card access applications; 6.6 x 4.5m (21 x 15 ft) - security applications
Pet Immunity	Up to 40 kg (90 lb)	Up to 40 kg (90 lb)	-	-	-	-	Up to 18 kg (40 lb)	-
Digital Detection	▲	-	▲	▲	▲	-	-	-
Auto Temperature Compensation	▲	▲	▲	▲	▲	▲	▲	▲
Alarm Output	EVO Bus	EVO Bus / 2x Solid State, N.C. 150 mA	Solid State, N.C. 150 mA	28 Vdc, 0.15A, N.C.	100 mA / 28 Vdc, N.C.	28 Vdc, 0.15A, N.C.	28 Vdc, 0.15A, N.C.	28 Vdc, 0.15A, N.C. or N.O.
Dual Edge Processing	▲	▲	▲	▲	-	-	-	-
EVO Bus	▲	▲	-	▲	-	-	-	-
Operating Temperature	-20 to 50 °C (-4 to 122 °F)	-35 to 50° C (-31 to 122° F)	-20 to 50 °C (-4 to 122 °F)	-20 to 50 °C (-4 to 122 °F)	-20 to 50 °C (-4 to 122 °F)	-20 to 50 °C (-4 to 122 °F)	-20 to 50 °C (-4 to 122 °F)	-10 to 50 °C (14 to 122 °F)
Certification	CE	CE EN 50131 GRADE 3	CE	CE	CE	CE	CE	-

▲ = included feature

*Compatible only with EVO Control Panels

Wireless Motion Detectors

Indoor



PMD2P

Wireless PIR Motion Detector with Pet Tolerance

► Features

- Dual element PIR sensor
- Auto-Pulse Signal Processing* (APSP) with Automatic Temperature Compensation
- Dual tamper mechanism (wall / cover)
- Can be used with SB469 Swivel-Mount Bracket

► Specifications

Detection Range	11 x 11m (36 x 36 ft), 15m (50 ft) for center beams; 88.5°
Pet Tolerance	Up to 18 kg (40 lb)
Power	3 x AAA alkaline batteries
Battery Life	2 years
RF Frequency	433 or 868 MHz
Operating Temperature	0 to 50 °C (32 to 122 °F)
Dimensions / Weight	6.5 x 12.5 x 5.2 cm (2.5 x 4.9 x 2.0 in.) / 105g (3.7 oz) with batteries

Top View

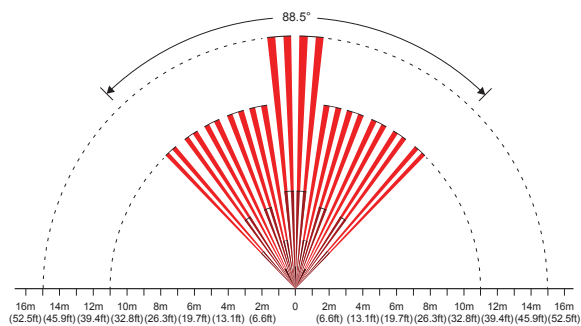

Side View

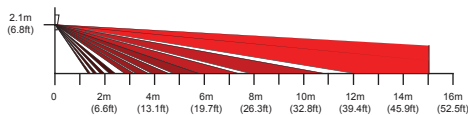

PMD75

Wireless Digital Dual-Optic PIR Motion Detector with Pet Immunity

► Features

- 2 x Dual-opposed element PIR sensors
- Auto-Pulse Signal Processing* (APSP) with Automatic Temperature Compensation
- Anti-tamper switch
- Digital motion detection
- Digital Shield algorithm software, with adjustable sensitivity
- Can be used with SB469 Swivel-Mount Bracket

► Specifications

Detection Range	11 x 11m (36 x 36 ft), 15m (50 ft) for center beams; 90°
Pet Immunity	Up to 40 kg (90 lbs)
Power	3 x AAA alkaline batteries
Battery Life	2 years
RF Frequency	433 or 868 MHz
Operating Temperature	0 to 50 °C (32 to 122 °F)
Dimensions	6.6 x 12.4 x 6.1 cm (2.6 x 4.9 x 2.4 in.)

Top View

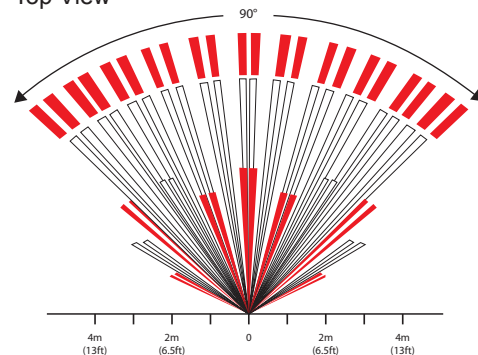

Side View

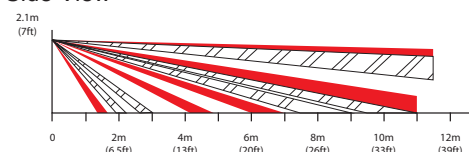

Wireless Motion Detectors

Indoor

New!



NV75MR

Wireless 16M Dual Mironel Optics Pet Immune Anti-Mask Detector

► Features

- 16 meter Dual Mironel detectors
- Active Anti-mask IR detection
- Wireless internal frequency selection
- Mechanical activation Creep Zone
- Dual / Single Edge operation
- Dual Tamper (cover and wall)
- Wall or corner mount
- Optional bracket (HDB7)

► Specifications

Detection Range	16m (52 ft); 90°
Pet Immunity	Up to 50 cm
Power	2 x AA Alkaline batteries
RF Frequency	433 or 868 MHz
Battery Life	Up to 3 years for typical use
Operating Temperature	-35 to 50° C (-31 to 122° F)
Dimensions	12.8 x 6.2 x 5.4 cm (5.1 x 2.4 x 2.1 in.)

Top View

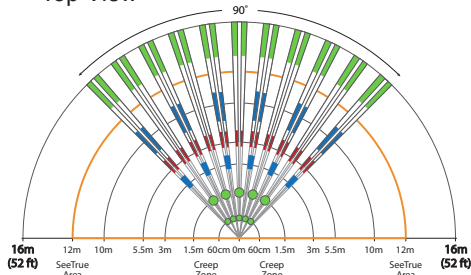

Side View (Pet Immunity Mode)

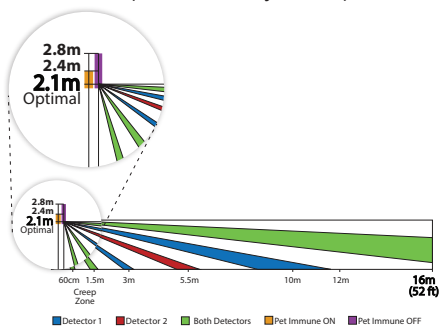

Wireless Motion Detectors

Outdoor

New!



NV780MR

Wireless Dual Side-View Outdoor Detectors with Anti-Masking and Pet Immunity

► Features

- Dual side anti-masking detection – Active IR detection, fast 20 seconds detection designed for outdoor detection of sprayed liquids and blocking items up to 25 cm (10 in.)
- Pet Immunity capability, up to 40 kg (90 lb)
- 4 dual element sensors arrangement
- High efficiency long focal point (1.77 in.) LoDiff lens
- Combination optics – mirror and Fresnel lens for optimal sharp detection
- Wireless frequency selection NV780MR supports two internally selectable frequencies
- Single or Dual operation modes
- Optical and digital range adjustments
- Dual LED and buzzer indicators
- Wall-mount, with built-in level tool

► Specifications

Detection Range	2 x 3m to 12m (9.8 to 39 ft) at 2.5m height
Pet Immunity	Up to 40 kg (90 lb)
Power	3x AA alkaline battery
RF Frequency	433 or 868 MHz
Battery Life	3 years
IP Rating	IP54
Operating Temperature	-35 to 50° C (-31 to 122° F)
Dimensions	21 x 11 x 7 cm (8.2 x 4.3 x 2.7 in.)

Wall (Top View)

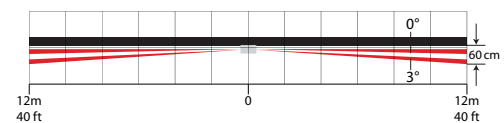

Range Adjustment

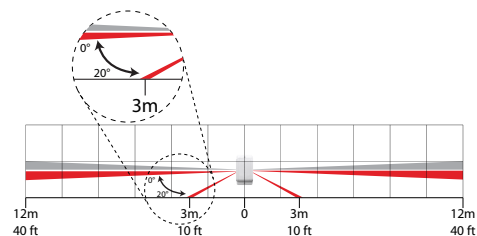

Wireless Motion Detectors

Outdoor



NV35MR

Wireless Outdoor / Indoor Window and Sliding Door Dual Detector with Anti-Masking and Pet Immunity

► Features

- Outdoor / indoor protection solution for windows and sliding doors
- Pet Immune detection
- Anti-masking - Active IR detection for sprayed liquids and blocking items up to 30 cm (11.8 in.)
- Dual detectors controlled by Full Authority Digital Electronics Control (FADEC)
- Optical pet discrimination geometry to support Super Pet Immunity
- Dual tamper detection
- Creep zone detection

► Specifications

Detection Range	Super Pet Immunity Mode: 7.5 x 2m (25 x 7 ft) Sharp Mode (Pet Immunity off): 10 x 2m (33 x 7 ft)
Pet Immunity	Pet size approximately 50 cm
Power	2 x AA Alkaline batteries
RF Frequency	433 or 868 MHz
Battery Life	Up to 3 years for typical use
IP Rating	IP54
Operating Temperature	-35 to 60° C (-31 to 140° F)
Dimensions	12.3 x 6.1 x 4.3 cm (4.8 x 2.4 x 1.7 in.)

Top View

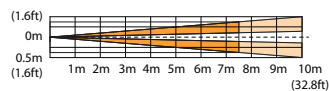

Side View (Pet Immunity Mode)

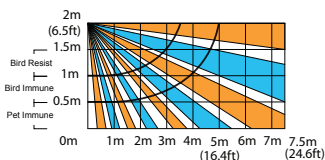

Side View (Sharp Mode Use Only)

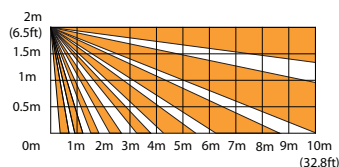

PMD85

Wireless Outdoor Digital Dual-Optic PIR Motion Detector

► Features

- 2 x Dual-opposed element PIR sensors
- Increased white light rejection for highly reliable detection
- Available with 1 of 3 lenses: Pet Array, Horizontal Curtain Beam, or Vertical Curtain Beam
- Dual-optical Filtering System, with UV-protected lens
- Auto-Pulse Signal Processing* (APSP) with temperature compensation
- Multi-level sensitivity adjustment
- Can be used with SB85 Heavy Duty Outdoor Swivel Bracket

► Specifications

Detection Range	11 x 11m (36 ft); 90° - Pet Array
Pet Immunity	Up to 40 kg (90 lb)
Power	3 x AA alkaline batteries
RF Frequency	433 or 868 MHz
Battery Life	3 years
IP Rating	IPX4
Operating Temperature	-35 to 50 °C (-31 to 122 °F)
Dimensions	7.9 x 17.5 x 6.6 cm (3.1 x 6.9 x 2.6 in.)

Pet Array

Top View

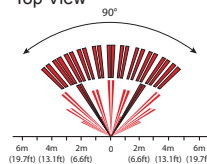

Side View

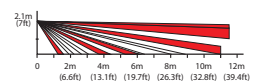

Horizontal Curtain Beam

Top View

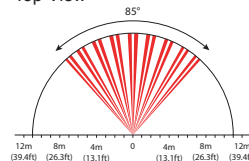

Side View

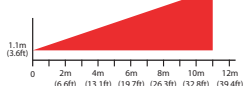

Vertical Curtain Beam

Top View

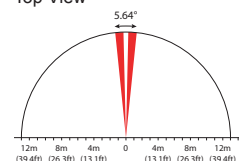

Side View

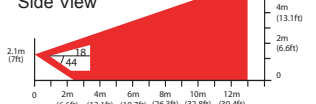

* Patented

Wireless Perimeter Detectors Glass Break Detector



G550 Wireless Glass Break Detector

► Features

- Detects breaking of different types of glass including plated, tempered, laminated and wired
- Wireless range: 6 meter (20 ft) radius range and 360° coverage pattern protects an entire room with one sensor
- Factory-set sensitivity for quick and safe installation

► Specifications

Power	3 x AAA alkaline batteries
RF Frequency	433 or 868 MHz
Battery Life	2 years
Wireless Range	20m (65 ft) with MG6250 40m (130 ft) with MG5000 / MG5050 / RTX3; in a typical residential environment
Operating Temperature	0 to 50 °C (32 to 120 °F)
Dimensions	10.9 x 7.9 x 4.3 cm (4.3 x 3.1 x 1.7 in.)

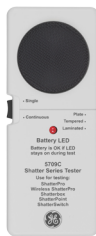

5709C Acoustic Glass Break Sensor Tester

► Features

- Compatibility with the G550 Wireless Glass Break Detector
- Provides real glass break sounds
- Recommended size of glass: 1 x 2 ft or larger; Minimum 1 x 1 ft
- Recommended for glass thickness as follows:
 - Plate glass: 3/3 to 1/4 in.
 - Tempered glass: 1/8 to 1/4 in.
 - Laminated glass: 1/8 to 1/4 in.

► Specifications

Battery Type	9V
Operating Temperature	0 to 49 °C (32 to 120 °F)
Dimensions	15.9 x 2.8 x 6.4 cm (6.3 x 1.1 x 2.5 in.)

Wireless Perimeter Detectors Door Contact



DCT10 Wireless Long-Range Door Contact

► Features

- 2-zone capabilities where each zone is independent and has its own serial number
 - Zone 1: One of two high-sensitivity reed switches on board (magnet included)
 - Zone 2: Universal input (N.O. / N.C.)
- Low battery and signal transmission LED
- Anti-tamper switch

► Specifications

Input Response Time	45 ms
Power	4.5 Vdc (3 x AAA alkaline batteries)
RF Frequency	433 or 868 MHz
Battery Life	Up to 3 years
Wireless Range	Typical in a residential environment 30m (100 ft) with MG6250 70m (230 ft) with MG5000 / MG5050 / RTX3 / K32LX / K641LX
Operating Temperature	0 to 50 °C (32 to 122 °F)
Dimensions	12.4 x 4.5 x 3.3 cm (4.9 x 1.8 x 1.3 in.)



DCT2 Wireless Door Contact

► Features

- One high-sensitivity reed switch (magnet included)
- Anti-tamper switch
- Built-in strip antenna (printed)

► Specifications

Power	1 x 3V lithium battery (DL2450)
RF Frequency	433 or 868 MHz
Battery Life	Between 1 and 5 years
Wireless Range	20m (65 ft) with MG6250 40m (130 ft) with MG5000 / MG5050 / RTX3; in a typical residential environment
Operating Temperature	0 to 50 °C (32 to 122 °F)
Dimensions	4.3 x 3 x 1.8 cm (1.7 x 1.2 x 0.7 in.)



Wireless Perimeter Detectors

Door Contact



DCTXP2

Wireless Door Contact

► Features

- ▶ 2-zone capabilities where each zone is independent and has its own serial number
 - Zone 1: One of two high-sensitivity reed switches on board (magnet included)
 - Zone 2: Universal input (N.O. / N.C.)
- ▶ Anti-tamper switch
- ▶ Available in brown and white
- ▶ Built-in strip antenna (printed)

► Specifications

Power	3 Vac, 2 x AAA alkaline batteries
RF Frequency	433 or 868 MHz
Battery Life	Between 1 and 5 years
Wireless Range	20m (65 ft) with MG6250 40m (130 ft) with MG5000 / MG5050 / RTX3; in a typical residential environment
Operating Temperature	-10 to 55 °C (14 to 131 °F)
Dimensions	4.3 x 3 x 1.8 cm (1.7 x 1.2 x 0.7 in.)



Wireless Special Detectors

Multi-Axis Movement Detector



GS250

Multi-Axis Movement Detector

► Features

- ▶ Three-axis (X, Y, and Z axis) accelerometer detection
- ▶ Adjustable sensitivity for any installation
- ▶ Wireless range: Approximately 100m (328 ft) in line of sight
- ▶ Power saving mode (conserves battery life)
- ▶ Status LEDs indications for: Power-up, Test Mode, Movement, Tamper, Alarm

► Specifications

Power	1 x 3V lithium battery (CR2032 / DL2032) included
RF Frequency	433 or 868 MHz
Battery Life	2 years based on two detections per week
Wireless Range	Up to 100m (328 ft) in line of sight
Operating Temperature	0 to 50 °C (32 to 122 °F)
Dimensions	2.7 x 7.5 x 0.64 cm (1.1 x 3 x 0.25 in.)

Wireless Safety Detectors



SD360

Wireless Ceiling-Mount Smoke Detector (Everday)

► Features

- ▶ High-sensitivity photoelectric smoke sensor
- ▶ Built-in siren
- ▶ Test / Hush button
- ▶ LED operation indication

► Specifications

Detection Type	Photoelectric Chamber
Power	3V lithium battery, Duracell or Panasonic CR123A (3 Vdc)
RF Frequency	433 or 868 MHz (868 MHz RF certification pending)
Battery Life	3 years
Alarm Level / Sensitivity	1.38 to 2.36%/ft
Standby Current	25 uA
Alarm Sound Level	85 dB at 10 ft
Humidity	10 ~ 85%
Operating Temperature	0 to 49 °C (32 to 120 °F)
Dimensions	12 cm diameter x 5 cm depth (4.7 x 0.2 in.)

* To comply with ETL / ETLc, SD360 must be installed with SP6000 or EVO192

* ETL / cETL is valid for 433MHz only



Wired Motion Detectors

Digital Indoor

New!



NV75M / MX / MW

16M Dual Mironel Optics Pet Immune Anti-Mask Detector

Features

- ▶ 16 meter Dual Mironel detectors
- ▶ Active Anti-Mask IR detection
- ▶ Mechanical activation Creep Zone
- ▶ Dual / Single Edge operation
- ▶ Dual Tamper (cover and wall)
- ▶ Wall or corner mount
- ▶ Optional bracket (HDB7)

Features specific to NV75MX

- ▶ Clean Lens notice
- ▶ EVO bus connection

Feature specific to NV75MW

- ▶ 12 meter SeeTrue range

Specifications

Detection Range	16m (52 ft); 90°
Pet Immunity	Up to 50 cm
Input Voltage	12 to 15 Vdc
Current Consumption	23 mA
Alarm Output	2x Solid State, N.C. 150 mA
Operating Temperature	-35 to 50° C (-31 to 122° F)
Dimensions	12.8 x 6.2 x 5.4 cm (5.1 x 2.4 x 2.1 in.)



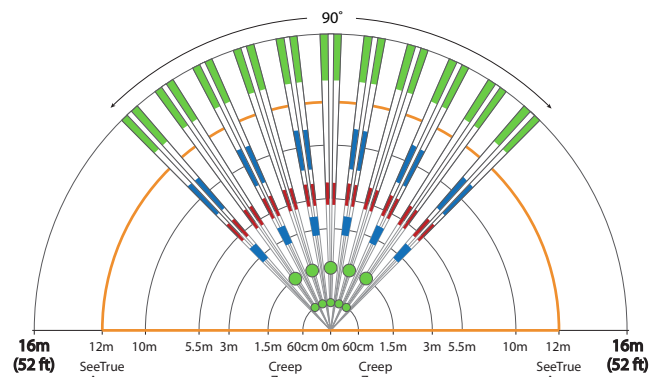

Top View

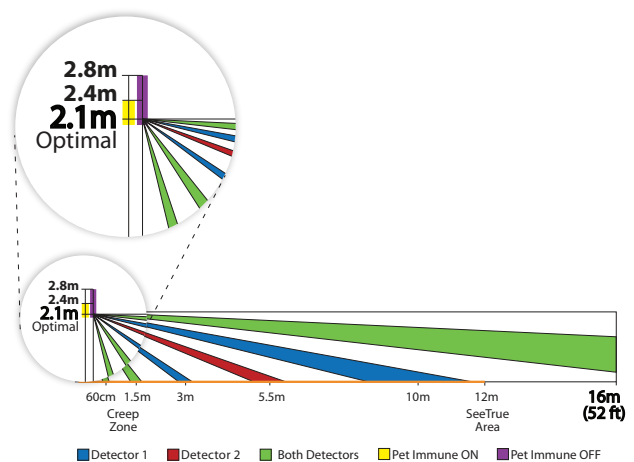

Side View (Pet Immunity Mode)



For full details on Wired Indoor / Outdoor Motion Detectors:

 <p>NVX80 Powerful Motion Detector with MW Anti-Mask and SeeTrue™ Technology for Outdoor / Indoor Use Refer to page 12</p>	 <p>NV780MX Dual Side-View Outdoor Detector Refer to page 10</p>	 <p>DG85 Outdoor Digital Motion Detector with Pet Immunity Refer to page 11</p>	 <p>DG457 Glass Break Detector Refer to page 12</p>
--	--	---	---



Wired Motion Detectors

Digital Indoor



DG55+

Dual Element Digital PIR Motion Detector

► Features

- Dual element PIR sensor
- Digital motion detection
- Auto-Pulse Signal Processing* (APSP) and Dual Edge Processing
- Anti-tamper switch
- More lenses are available
- Can be used with SB469 Swivel-Mount Bracket

► Specifications

Detection Range	12 x 12m (40 x 40 ft); 110°
Input Voltage	11 to 16 Vdc
Current Consumption	Typical: 6 mA Maximum: 15 mA
Alarm Output	Form A relay, N.C. and optional form C relay, N.C. / N.O.
Operating Temperature	5 to 40 °C (41 to 104 °F) UL / ULC Tested: 0 to 49 °C (32 to 120 °F)
Dimensions	6.6 x 9.9 x 6.1 cm (2.6 x 3.9 x 2.4 in.)

Top View

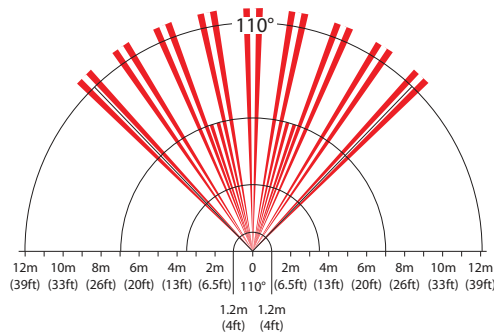

Side View

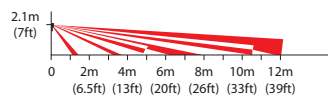

DG65+

Quad Element Digital PIR Motion Detector

► Features

- Quad opposed element PIR sensors
- Digital Dual-opposed detection
- Interlock sensor geometry
- Auto-Pulse Signal Processing* (APSP) and Dual Edge Processing
- Anti-tamper switch
- More lenses are available
- Can be used with SB469 Swivel-Mount Bracket

► Specifications

Detection Range	12 x 12m (40 x 40 ft) at 110°
Input Voltage	11 to 16 Vdc
Current Consumption	Typical: 6 mA Maximum: 15 mA
Alarm Output	Form A relay, N.C. and optional form C relay, N.C. / N.O.
Operating Temperature	5 to 40 °C (41 to 104 °F) UL / ULC Tested: 0 to 49 °C (32 to 120 °F)
Dimensions	6.6 x 9.9 x 6.1 cm (2.6 x 3.9 x 2.4 in.)

Top View

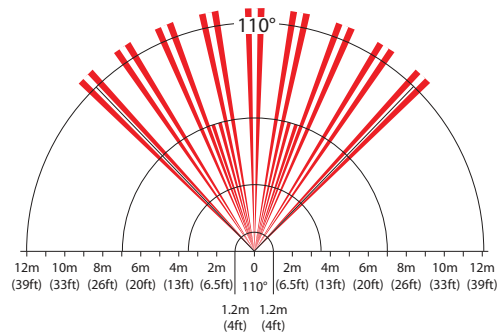

Side View

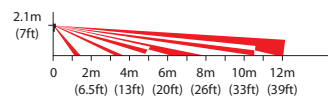

Wired Motion Detectors

Digital Indoor



DG75+

Two Dual Element Digital PIR Motion Detector with Pet Immunity

► Features

- 2 x dual opposed element PIR sensors
- Auto-Pulse Signal Processing* (APSP) and Dual Edge Processing
- Anti-tamper switch
- Can be used with SB469 Swivel-Mount Bracket

► Specifications

Detection Range	11 x 11m (36 x 36 ft); 90°
Pet Immunity	Up to 40 kg (90 lb)
Input Voltage	11 to 16 Vdc
Current Consumption	Typical: 15 mA Maximum: 40 mA
Alarm Output	Form A relay, N.C. and optional Form C relay, N.C. / N.O.
Operating Temperature	-20 to 50 °C (-4 to 122 °F)
Dimensions	6.6 x 12.4 x 6.1 cm (2.6 x 4.9 x 2.4 in.)

Top View

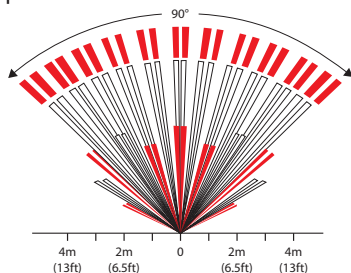

Side View

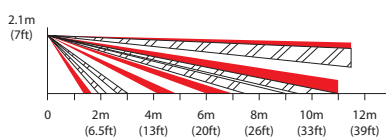

525DM

Dual Technology Digital Motion Detector with Dynamic Proximity Detection

► Features

- Microwave and dual element PIR
- Dynamic proximity feature allows for the detection of close proximity movements (less than 0.75m / 2.5 ft) within the detector range
- Adjustable microwave range
- Two auto pulse settings; for typical environment (normal), or for high false alarm rejection (high)
- Enhanced and well-balanced sensitivity adjustment
- Installer Test Mode: allows testing of microwave and infrared detection separately
- LED feedback displays dynamic proximity and installer test features
- Can be used with SB469 Swivel-Mount Bracket

► Specifications

Detection Range	12 x 12m (40 x 40 ft), 90°
Input Voltage	10 to 16 Vdc
Current Consumption	Typical: 30 mA
Microwave Frequency	10.525 GHz
Operating Temperature	-20 to 50 °C (-4 to 122 °F)
Dimensions	6.6 x 12.7 x 5.6 cm (2.6 x 5 x 2.2 in.)

Top View

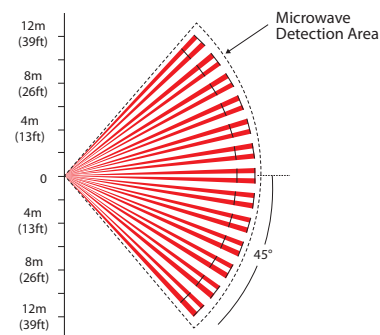

Side View

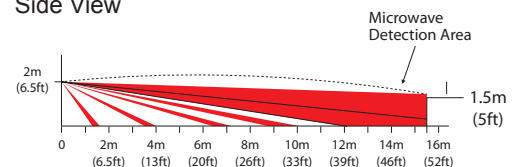

Wired Motion Detectors

Digital Indoor



NV5

Digital PIR Motion Detector with Pet Tolerance

Features

- ▶ Dual element PIR sensor managed by Full Authority Digital Electronics Control (FADEC)
- ▶ Auto-Pulse Signal Processing* (APSP) and Dual Edge Processing with settings for normal or high interference environments
- ▶ Auto temperature compensation
- ▶ Anti-tamper switch
- ▶ NV5 can be used with SB100 Wall and Ceiling Bracket

Specifications

Detection Range	10 x 10m (32.8 x 32.8 ft); 102° with Creep zone
Pet Immunity	Up to 16 kg (35 lb)
Input Voltage	10 to 15 Vdc
Current Consumption	Typical: 10 mA Maximum: 11 mA
Alarm Output	Solid State, N.C.
Operating Temperature	-10 to 50 °C (14 to 122 °F)
Dimensions	9.1 x 5.5 x 4 cm (3.5 x 2.2 x 1.6 in.)

Top View

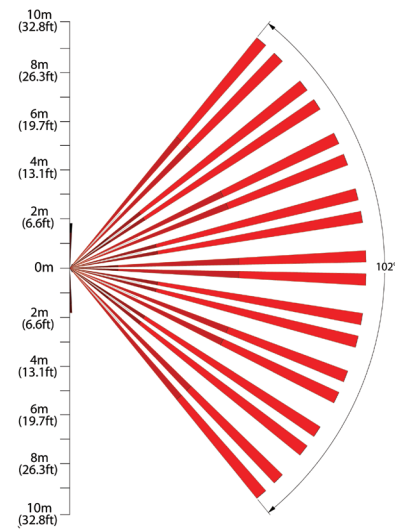

Side View

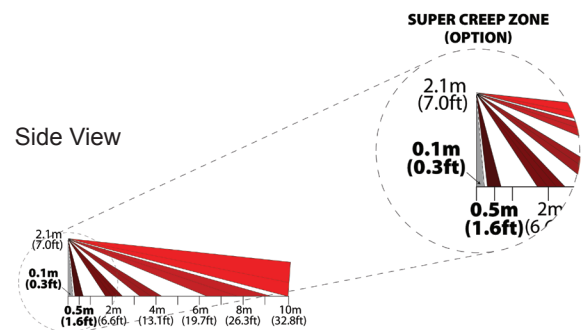

Wired Motion Detectors

Outdoor



NV35M

Outdoor / Indoor Window and Sliding Door Dual Detector with Anti-Masking and Pet Immunity

► Features

- Outdoor / indoor protection solution for windows and sliding doors
- Pet Immune detection
- Anti-masking - Active IR detection for sprayed liquids and blocking items up to 30 cm (11.8 in.)
- Dual detectors controlled by Full Authority Digital Electronics Control (FADEC)
- Optical pet discrimination geometry to support Super Pet Immunity
- Dual tamper detection
- Creep zone detection

► Specifications

Detection Range	Super Pet Immunity Mode: 7.5 x 2m (25 x 7 ft) Sharp Mode (Pet Immunity off): 10 x 2m (33 x 7 ft)
Pet Immunity	Pet size approximately 50 cm
Input Voltage	12 to 15 Vdc
RF Frequency	433 or 868 MHz
IP Rating	IP54
Operating Temperature	-35 to 60° C (-31 to 140° F)
Dimensions	12.3 x 6.1 x 4.3 cm (4.8 x 2.4 x 1.7 in.)

Top View

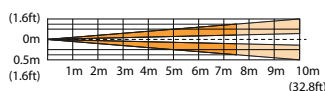

Side View (Pet Immunity Mode)

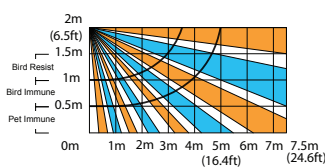

Side View (Sharp Mode Use Only)

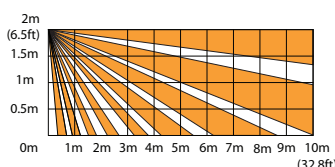

Wired Motion Detectors

Digital Ceiling

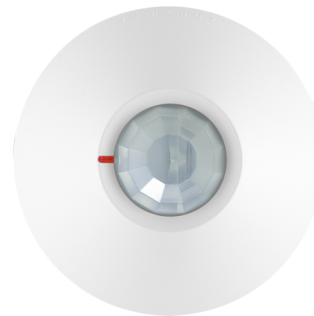

DG466

Directional Ceiling-Mount Digital Motion Detector

► Features

- Ideal for protecting balcony and patio doors
- Two dual element, low noise PIR sensors
- Anti-tamper switch
- Adjustable return delay timer (exit and re-enter without triggering an alarm)
- Directional detection to produce an alarm when a target moves in a specific direction

► Specifications

Detection Range	67 cm x 4.8m (2.2 ft x 16 ft) and 60 cm x 4.8m (2 ft x 16 ft)
Input Voltage	11 to 16 Vdc
Current Consumption	Typical: 25 mA Maximum: 35 mA
Alarm Output	Form A relay, N.C.
Operating Temperature	-20 to 50 °C (-4 to 122 °F)
Dimensions	10.8 diameter x 13.5 cm depth (4.25 x 1.38 in.)

Side View

Front View

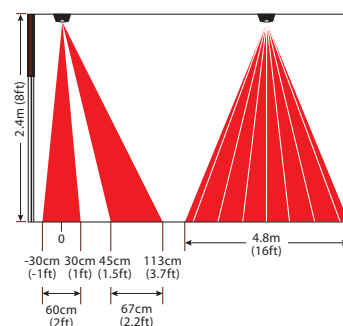

For full details on:



DG467

360° Ceiling-Mounted Digital Motion Detector

Refer to page 09



Wired Motion Detectors

Analog



476

Analog Single-Optic PIR

► Features

- Dual element PIR sensor
- Anti-tamper switch
- Auto-Pulse Signal Processing* (APSP)
- Can be used with SB469 Swivel-Mount Bracket

► Specifications

Detection Range	10.6 x 10.6m (35 x 35 ft); 110°
Input Voltage	9 to 16 Vdc
Current Consumption	Typical: 15 mA Maximum: 31 mA
Alarm Output	Form A relay, N.C.
Operating Temperature	-20 to 50 °C (-4 to 122 °F)
Dimensions	6.6 x 9.3 x 5.2 cm (2.6 x 3.7 x 2 in.)

Top View

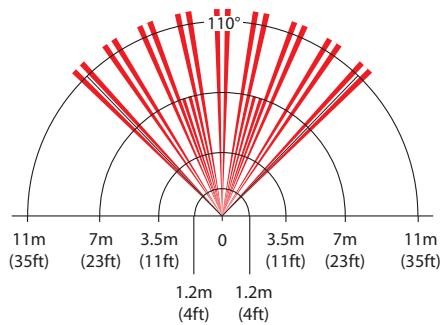

Side View

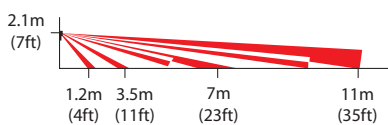

476PET

Analog Single-Optic PIR with Pet Immunity

► Features

- Dual element PIR sensors
- Anti-tamper switch
- Auto-Pulse Signal Processing* (APSP)
- Can be used with SB469 Swivel-Mount Bracket

► Specifications

Detection Range	11 x 11m (35 x 35 ft) and up to 15m (50 ft) for center beams; 88.5°
Pet Immunity	Up to 18 kg (40 lb)
Input Voltage	9 to 16 Vdc
Current Consumption	Typical: 15 mA Maximum: 29 mA
Alarm Output	Form A relay, N.C.
Operating Temperature	-20 to 50 °C (-4 to 122 °F)
Dimensions	6.6 x 9.3 x 5.2 cm (2.6 x 3.7 x 2 in.)

Top View

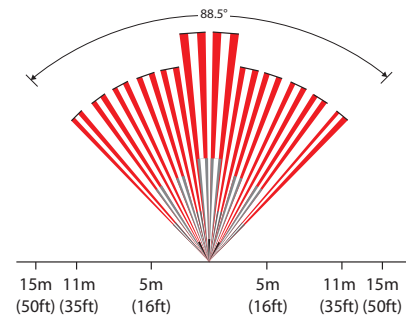

Side View

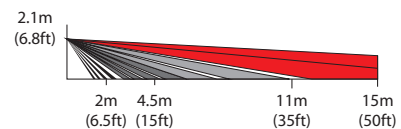

Wired Motion Detectors

Analog



460

Vertical View PIR Motion Detector

► Features

- Ideal for entry / exit protection and exit access requests
- Dual element PIR sensor
- Anti-tamper switch
- Adjustable lens position (0° or 10°)

► Specifications

Detection Range	Hand-sized objects for card access applications: 2 x 1.5m (7 x 5 ft) Body-sized objects for security applications: 6 x 4.5m (20 x 15 ft)
Input Voltage	(12 Vdc mode) 9 to 16 Vdc (24 Vdc mode) 20 to 27 Vdc
Current Consumption	Typical: 15 mA Maximum: 18 mA
Relay Output	N.C. or N.O.
Operating Temperature	-10 to 50 °C (14 to 122 °F)
Dimensions	11.4 x 9.2 x 3.2 cm (4.5 x 3.6 x 1.3 in.)

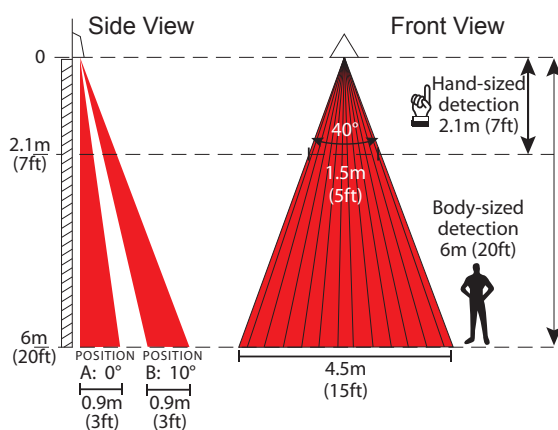

Wired Special Detectors

Vibration Detector



950

Safe Protector

► Features

- High-sensitivity piezoelectric element
- 5 sensitivity settings
- 2.5m (8.2 ft) protection range
- Anti-tamper switch

► Specifications

Input Voltage	10 to 16 Vdc
Current Consumption	Minimum: 12 mA Maximum: 16 mA
Diameter of Protected Surface	2.5m (8.2 ft)
Alarm Relay	28V / 150 mA
Operating Temperature	-20 to 50 °C (-4 to 122 °F)
Dimensions	6.4 x 11 x 2.4 cm (2.5 x 4.3 x 0.9 in.)



Accessories

Glass Break Sensor Tester



459

Test Trek

► Features

- Produces a test tone to verify the GlassTrek's high-audio frequency detection capability
- Dimensions: 8.2 x 14.3 x 3.8 cm (3.3 x 5.6 x 1.5 in.)

Wireless Sirens



SR130

Wireless Outdoor Siren with Built-in Strobe Light

► Features

- Built-in transceiver
- Wireless siren (100 dBA) with integrated strobe light
- Fast alarm response time (within 4 seconds)
- 2.5 hour alarm display (strobe flashes every 4 seconds after bell cutoff)
- Siren presence supervised by control panel
- Dual tamper mechanism (wall / cover)
- Siren test mode
- Signal strength / RF transmission and status LEDs
- Strobe lens available in 3 colors (red, blue and amber)
- In-field firmware upgradeable via 307USB

► Specifications

Power Supply	3 x C alkaline batteries (4.5 Vdc)
RF Frequency	Built-in transceiver 433 or 868 MHZ
Battery Life	3 years (typical use)
Wireless Range	Typical residential environment 35m (115 ft) with all-in-one consoles 70m (230 ft) with MG5000, MG5050 and RTX3
Siren	100 dBA
Humidity	5 to 95%
IP Rating	IPX4
Operating Temperature	-25° to 55° C (-13° to 131° F)
Dimensions	13.4 x 21.17 x 5.1 cm (5.29 x 8.34 x 2.01 in.)



SR150

Wireless Outdoor Siren with Built-in Strobe Light

► Features

- Built-in transceiver
- Wireless siren (100 dBA) with integrated strobe light
- Weather-resistant design using a PC / ABS enclosure with UV protection and a silicone coated PCB (-20 to 50 °C / -4 to 122 °F)
- Battery powered with optional external AC / DC power
- Fast alarm response time (4 seconds)
- 2.5 hour alarm display (strobe flashes every 4 seconds after bell cut-off)
- Siren presence supervised by control panel
- Dual tamper protection (cover removal, and removal from wall)
- Siren test mode
- 4-LED signal strength and status display
- Strobe lens available in 4 colors (red, blue, amber, and clear)
- In-field firmware upgradeable via 307USB

► Specifications

Power	3 x D alkaline batteries (4.5 Vdc) - Optional 8 to 16 Vac / 9 to 20 Vdc external power
Battery Life	Up to 3 years (typical use)
Current Consumption	Sleep: 22 uA Standby: 130 uA Alarm: 550 mA
Wireless Range	Typical residential environment 35m (115 ft) with all-in-one consoles 70m (230 ft) with MG5000, MG5050, RTX3 and K32LX
Siren	100 dBA (1 meter)
Humidity	93%
IP Rating	IPX4
Operating Temperature	-30 to 50 °C (-22 to 122 °F)
Dimensions / Weight	24 x 6 x 18 cm (9.5 x 2.3 x 7 in.) / 1.08 kg (2.4 lb) without batteries

GPRS / IP Receiver



IPR512
Monitoring Receiver

► Features

- 1024 supervised Paradox GPRS / IP modules using a PCS Series module or IP150 Internet module
- End-to-end supervision
- Module polling and receiver supervision
- Direct communication – all reports are transmitted directly to the receiver from a PCS Series module or IP150 Internet module without having to use intermediary servers or network operation centers
- Redundant Internet Service Provider (ISP) – two Ethernet ports to receive events through two different ISPs
- 2 serial ports
- Automation software communication protocols – supports ADEMCO 685, SURGARD MLR2-DG, or RADIONICS 6500
- Integrated Account Management web page
- Data backup on external memory card
- Firmware upgradeable
- 256-bit AES data encryption
- 2-line, 40-character LCD with a 6-button interface to view troubles, backup data to / from memory card, set IP Address and Subnet Mask for LAN port, set LCD language, backlight and contrast, set time and date
- Supports 19 in. rack mounting (1U) or desktop installation
- Output relay (triggered by selected events)
- Input relay (sends selected events when triggered)
- Automatic date and time synchronization via Network Time Protocol (NTP)
- Robust and durable construction
- Standard 110 / 220 Vac power supply
- Extremely low noise and low Current Consumption (less than 10W)
- Secures private operating system

► Specifications

Input Voltage	100 to 240 Vac (50-60 Hz)
Input Power	10W
Operating Temperature	-10 to 55 °C (14 to 131 °F)
Dimensions / Weight	4.2 x 42.8 x 30.4 cm (1.66 x 16.84 x 11.96 in.) / 3.28 kg (7.2 lb.)

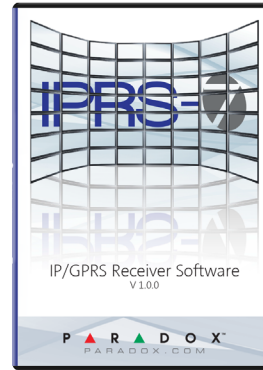

IPRS-7
IP / GPRS PC Receiver Software

► Features

- Desktop application that emulates the IPR512 GPRS / IP Monitoring Receiver, with unlimited # of accounts
- Automation software communication protocols – supports ADEMCO 685, SURGARD MLR2-DG, or RADIONICS 6500
- Buffers and manages incoming events
- Displays and manages IP and GPRS devices without having to modify the panels
- Supports SMS registration and reporting protocol through commercial GSM / GPRS modem
- Allows software personalization through customer logo
- Installation setup is downloadable from the web
- Application auto-starts upon Windows start-up and always runs in background
- Connect and Arm / Disarm a system with login credentials
- Functions to import accounts from an IPR512
- Supports HD78 Camera video file events (360P)
- View live streaming of HD78 camera upon video alarm event; only if permitted by system master
- Module polling and receiver supervision
- Direct communication – all reports are transmitted directly to the receiver from a PCS Series Module or IP150 Internet Module without having to use intermediary servers or network operation centers
- SDK for automation software video verification integration
- Free SDK enables CMS automation software to control and receive both video and alarm for efficient event reporting

► System Requirements

Intel® Pentium® 4, 1.4 GHz processor or faster
Microsoft® Windows, XP, Vista, 2000 or Windows 7 platform
512 MB of RAM
100 MB of available hard-disk space for installation and database
An internet connection
Administrative rights on the PC where you will be installing the software
Port-forwarding configuration (required in order to enable IP / GPRS reporting)

Cellular Communicator Module



PCS250 / PCS250G GPRS / GSM Communicator Module

► Features

- Reports events to the IPR512 GPRS / IP Monitoring Receiver and / or the IPRS-7 PC Receiver Software
- Instant notification of panel supervision loss
- Easily Arm / Disarm the system via SMS
- Reports alarms via text messages to up to 16 cellular phone numbers
- Simple installation with 4-wire serial connection
- Supports 2 cellular provider SIM cards for provider redundancy
- Tamper switch support
- Messages are secured with 256-bit (AES) encryption
- Optional rod antenna can be installed up to 18m (60 ft) from the module using optional antenna cable extensions depending on the local signal strength

► Features specific to PCS250

- Send pre-recorded voice messages to up to eight telephone numbers to report alarms using the optional VDMP3 Paradox Plug-in Voice Module (GSM mode)
- Report via GSM (CID, SIA)

► Specifications

Power Class	Class 4 (2W at 850 / 900 MHz) Class 2 (1W at 1800 / 1900 MHz)
Antenna Bandwidth	70 / 80 / 140 / 170 MHz
Antenna Gain	<3 dBi; impedance 50 ohm <2W peak power
Voltage Input	12 Vdc nominal
Current Consumption	100 mA standby, average 450 mA (1.2A peak) during GPRS / GSM transmission
Encryption	128-bit (MD5 and RC4) and 256-bit (AES)
SMS Protocol	8-bit (IRA: ITU-T. 50) or 16-bit (UCS2 ISO / IEC10646)
Humidity	5 to 90%
Operating Temperature	0 to 50 °C (32 to 122 °F)
Dimensions / Weight	17.2 x 9.8 x 4.4 cm (6.8 x 3.9 x 1.7 in.) / 200g (7.05 oz)

Cellular New!



PCS260 / PCS265 4G / 3G / 2G / GSM Communicator Module

► Features

- 4G (3.75G) / 3G / 2G reporting data to IPR512 or IPRS-7 receivers
- 3G/2G auto connect if 4G not available
- Two SIM cards support for provider redundancy
- Control panel communication supervision
- Future ready for smartphone application access
- Arm or disarm the system via text message (SMS) to the PCS260/265
- 4-wire installation
- Dual tamper switch (wall and cover removal)
- Encrypted communication (128-bit AES)

► Feature specific to PCS265:

- Li-ion battery (included) allows operation when panel power is lost for backup reporting
- RS-485 connection to panel (one CVT485 included), allows 100m / 300 ft with battery charge
- Will report panel loss in case of cut wires or loss of power

► Specifications

Power Class	Class 4 (2W at 850 / 1900 MHz) Class 2 (1W at 1800 / 1900 MHz)
Antenna Bandwidth	5 bands, wideband
Voltage Input	12 Vdc nominal
Current Consumption	60 mA standby, 300 mA maximum
Encryption	128-bit (AES)
SMS Protocol	7-bit (GSM: 3GPP TS 23.038 / GSM03.38) or 16-bit (UCS2 ISO / IEC10646)
Humidity	0 to 90%
Operating Temperature	-20 to 50 °C (-4 to 122 °F)
Dimensions / Weight	20.8 x 7.5 x 2 cm (8.2 x 2.9 x 0.8 in.)

Voice Dialer

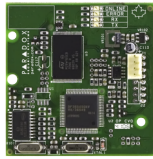

VDMP3 Voice Communicator

- ▶ **Features**
 - ▶ Records a "Site ID" to identify the installation site (Requires EVO V2.10 or higher to program and InField software)
 - ▶ Dials up to 8 telephone numbers to report a burglar, panic or fire alarm using prerecorded messages
 - ▶ Voice-guided menu
 - ▶ Arm / Disarm the system remotely via telephone
 - ▶ Controls PGMs and toggle utility keys remotely via telephone using DTMF
 - ▶ Connects directly onto the control panel
 - ▶ In-field firmware upgradeable via 307USB using EVO panel
- ▶ **Specifications**

Input Voltage	13.8 Vdc, supplied by the VDMP3 port
Current Consumption	35 mA
Audio Sample Rate	18.345 kHz
Dimensions	6.4 x 6.4 cm (2.5 x 2.5 in.)



Cellular Accessories



EXTKIT Antenna Extensions

- ▶ **Features**
 - ▶ Antenna extensions are available to improve reception by moving the antenna
 - ▶ Includes wall mounting bracket
 - ▶ The following models and lengths are available:
 - EXT2: 2m (6 ft) Coaxial Cable RG174
 - EXT4: 4m (12 ft) Coaxial Cable RG174
 - EXT7: 7m (24 ft) Coaxial Cable RG58
 - EXT15: 14.5m (48 ft) Coaxial Cable RG58
 - EXT18: 18m (60 ft) Coaxial Cable RG58

IP Communication Cable



COMCABLE Communication Cable

- ▶ **Features**
 - ▶ Directly connects the IP150 serial output to the PCS250 / 250G / 260 / 265, or to the control panel's serial port

Cellular Converter

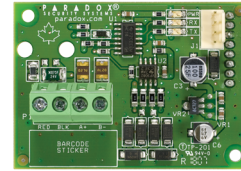

CVT485 Plug-In RS485 Converter

- ▶ **Features**
 - ▶ Converts serial to RS485, allowing a connection of the PCS250 / 265 up to 300m (1000 ft) from the control panel for better reception and / or to help conceal the module
 - ▶ Mounts directly onto the control panel
 - ▶ Only compatible when reporting via GSM to the central monitoring station
 - ▶ Dimensions: 6.3 x 4.5 x 2.8 cm (2.5 x 1.8 x 1.1 in.)

IP Internet Module



IP150 IP Communicator

- ▶ **Features**
 - ▶ Reports control panel events via IP to the Paradox IPR512 GPRS / IP Monitoring Receiver and / or IPRS-7 GPRS / IP PC Receiver Software
 - ▶ Built-in web interface for easy configuration (requires port forwarding configuration)
 - ▶ Controls and monitors a control panel through an IP network (LAN / WAN / Internet)
 - ▶ Views live status of all zones and partitions (e.g., open / close, arm / disarm, troubles and alarms) via web browser
 - ▶ Arm / Disarm individual partitions via web browser
 - ▶ Event log on web interface; displays last 64 events
 - ▶ Sends notification and alarm system events via email
 - ▶ SSL support for sending secured emails via a secure sockets layer
 - ▶ HTTPS support for improved security
 - ▶ Two I/Os on board; controlled via the web interface, triggering an email
 - ▶ Enables iParadox, NEware, or BabyWare to access your system through the Internet
 - ▶ ParadoxMyHome available for dynamic IP address
 - ▶ Very low bandwidth consumption
 - ▶ Built-in clip for mounting in a metal box
 - ▶ Supports multiple languages

- ▶ **Specifications**

Browser Requirement	Optimized for Internet Explorer 9 or higher, Mozilla Firefox 18 or higher, and Google Chrome, 1024 x 768 resolution minimum
Encryption	AES 256-bit, MD5 and RC4
Input Voltage	13.8 Vdc, supplied by the panel serial port
Current Consumption	100 mA
Dimensions	10.9 x 2.7 x 2.2 cm (4.3 x 1.1 x 0.9 in.)



EN 50131
GRADE 3

EN 50130-5
CLASS II

EN 50136
AIS 5

EN 45011
SYSTEM 5

ANSI/SIA CP-01-2010

Security Accessories



CV4USB RS-485 / RS-232 Converter Kit

- ▶ Features
- ▶ Incorporates a USB port and a serial port (DB-9)
- ▶ Enables control panel to communicate with a PC at 300m (1000 ft)
- ▶ Connects from the control panel's serial port connector to PC's serial port (DB-9) or USB port
- ▶ 38.4k baud communication (EVO) or 19.2k baud communication
- ▶ Dimensions: 6.2 x 7.2 x 3.4 cm (2.4 x 2.8 x 1.3 in.)



PS817 Power Supply

▶ Specifications

Rating	1.75A* continuous rating, 2A peak output
Input Voltage	16.5 Vac
DC Voltage Output	13.8 Vdc
Charge Current	280 mA or 700 mA selectable
LED Indication	Indicate charging status
Short Circuit Protection	Built-in
Dimensions	7.5 x 5.8 cm (2.95 x 2.3 in.)

* Requires a 16 Vac 40VA transformer



307USB Direct Connection Interface

- ▶ Features
- ▶ Incorporates a USB port and a serial port (DB-9)
- ▶ Enables control panel to communicate with a PC at 60m (200 ft)
- ▶ Connects from the control panel's serial port connector to a PC's serial (DB-9) or USB port
- ▶ Includes 3 LED status indicators (PC, Panel and RX / TX)
- ▶ Cable included
- ▶ Communication speed:
 - 57.6k baud (MG6250)
 - 38.4k baud (EVO)
 - 9.6k baud (MG Series and SP Series)
- ▶ Dimensions: 6.8 x 4.2 x 2.2 cm (2.7 x 1.7 x 0.9 in.)



PMC5 USB Memory Key

- ▶ Features
- ▶ Use to quickly transfer data to panel after uploaded by BabyWare
- ▶ Lock switch to prevent accidental loss of data
- ▶ LED status indication
- ▶ Download or upload control panel / console programming within seconds
- ▶ Connects directly to memory connector on the control panel / console
- ▶ No need for a telephone line, PC or any other peripheral device in the field
- ▶ Dimensions: 2.2 x 7.5 x 1 cm (0.9 x 3 x 0.4 in.)



TK278 Tamper Kit

- ▶ Features
- ▶ Use with Paradox or compatible metal boxes
- ▶ Protects against tampering (opening door or removal from wall)
- ▶ Dimensions: 2.9 x 8.7 x 4.4 cm (1.1 x 3.4 x 1.7 in.)

Security Accessories Boxes



Metal Boxes

- ▶ Features
- ▶ Provision for multiple module and panel mounting
- ▶ Many punch-out holes for simple wiring
- ▶ Easy door removal
- ▶ Dimensions available:
 - 20 x 25.5 x 7.6 cm (8 x 10 x 3 in.)
 - 28 x 28 x 7.6 cm (11 x 11 x 3 in.)



PBOX

- ▶ Features
- ▶ For use with ZX8SP, ZX8, RPT1, and PGM4
- ▶ Dimensions: 17.1 x 15.3 x 2.6 cm (6.7 x 6 x 1 in.)

Software



NWare

End-User Management Software

► Features

- Live system monitoring (view system, zone status, and troubles) without interrupting central station communication or system operation
- Views and monitors live streams of up to 4 HD777 cameras connected to an EVOHD control panel
- Arm / Disarm, bypass zones
- Programs access codes and settings of all users in an EVO192 and EVOHD system
- Search, sort and filter saved system events
- Generates and prints customized reports
- Supports internet (TCP / IP) communication (requires an IP Internet Module or PCS Module)
- On-site (local) uploading and downloading at 38.4k baud (EVO) using a 307USB Direct Connect Interface (60m / 200 ft) or a CV4USB Converter (300m / 1000 ft)
- Remote or local upload and download programming via an IP Internet Module or PCS Module
- Supports several languages simultaneously

► System Requirements

Windows XP®, Vista® (32 or 64-bit), Windows 7® (32 or 64-bit)

256 MB of RAM (512 MB of RAM suggested)

Pentium® III 800 MHz or higher

150 MB free disk space



IP Exploring Tools

IP Configuration Tools Application

► Features

- Enables you to set the module's IP address and other network settings
- Registers the module on our DNS service (paradoxmyhome.com)
- Performs on-site connection



BabyWare

PC Software

► Features

- Upload / download via GPRS, IP, landline, or direct connect via 307USB / CV4USB
- User friendly layout and operation
- Easy monitoring and site management tools
- Zone Test Mode: Tests for zone connectivity and operation
- Powerful and fast sort, search and print capability
- Data backup and powerful undo and recycle bin features
- Built-in translation tool

► System Requirements

Microsoft® Windows® / Vista / XP / 2000

512 MB of RAM (1 GB Recommended)

Intel® Pentium® 4, 1.4 GHz processor or faster

150 MB of available hard-disk space for installation (additional 150 MB recommended for multi-accounts and events)



InField

Firmware Upgrade Software

► Features

- Connects remotely via IP (IP Internet Module) or GPRS (PCS Series)
- Connects locally via 307USB, CV4USB or IP
- Built-in links to download the latest firmware (requires Internet connection)
- Automatic adjustment to the hardware's maximum transfer speed
- Records Voice ID for use with the VDMP3 Plug-In Voice Module

For full details on:











Insite GOLD App
Self-Monitoring Application
Refer to page 04

INDEX

- #s** 29 2WPGM
49 307USB
44 459
44 460
43 476
43 476PET
40 525DM
36 5709C
44 950
- A** 15 ACM12
29 ANTKIT
- B** 50 BabyWare
- C** 16 C702
16 C704
16 C705
16 C706
48 COMCABLE
49 CV4USB
48 CVT485
- D** 36 DCT10
36 DCT2
37 DCTXP2
12 DG457
42 DG466
09 DG467
39 DG55+
39 DG65+
40 DG75+
11 DG85
08 DM50
08 DM60
09 DM70
- E** 06 EVO192
06 EVOHD
48 EXTKIT
- G** 36 G550
29 GPRS14
37 GS250
- H** 04 HD78
04 HD78F
17 HUB2
- I** 50 InField
04 Insite GOLD App
48 IP150
50 IP Exploring Tool
46 IPR512
46 IPRS-7
- K** 24 K10H
24 K10V
24 K32+
22 K32LCD+
21 K32LX
23 K32RF
22 K35
23 K37
24 K636
07 K641+
07 K641LX
08 K641R
08 K656
- M** 49 Metal Boxes
28 MG5000
28 MG5050
28 MG6250
- N** 50 NEware
42 NV35M
35 NV35MR
10 NV35MX
41 NV5
38 NV75M
34 NV75MR
38 NV75MW
38 NV75MX
34 NV780MR
10 NV780MX
12 NVX80
- P** 29 PA6
29 PA7
29 PA12
49 PBOX
47 PCS250
47 PCS250G
47 PCS260
47 PCS265
17 PGM4
49 PMC5
33 PMD2P
33 PMD75
35 PMD85
17 PRT3
17 PS17
49 PS817
- R** 16 R910
15 R915
16 RAC1
30 REM1
30 REM101
30 REM15
30 REM2
30 REM25
30 REM3
25 RPT1
15 RTX3
25 RX1
- S** 37 SD360
19 SP4000
19 SP5500
20 SP6000
20 SP65
20 SP7000
45 SR130
45 SR150
- T** 49 TK278
07 TM50 (EVO)
21 TM50 (MG/SP)
- V** 48 VDMP3
- Z** 13 ZC1
13 ZX1
13 ZX4
13 ZX8
14 ZX8D
24 ZX8SP
14 ZX16D
14 ZX32D

ICON DESCRIPTION

Throughout the catalog, the icons shown below appear alongside product descriptions to which they apply.

	Anti-masking Technology		Pet Immunity
	Paradox Digital Detection Motion Detectors		SeeTrue™ Technology
	Digital Microwave Detection		Supports StayD™
	Organic Light-emitting Diode		RX / TX Transceiver Technology
	Outdoor Use		

LEGAL INFO

▶ Patents

U.S., Canadian and international patents may apply to our products. See www.paradox.com for more details.

▶ Trademarks

Paradox, BabyWare, SPECTRA, SPECTRA SP, Digiplex, Digiplex EVO, NEware, Stay-D, Paradox Digital Protection, Digigard, Digital Vision, Pet Immunity, GlassTrek, and MAGELLAN are trademarks or registered trademarks of Paradox Security Systems (Bahamas) Ltd. or its affiliates in Canada, the United States and / or other countries. All rights reserved. LODIFF® is a registered trademark of Fresnel Technologies Inc. Windows® is a registered trademark of Microsoft Corporation. ShatterPro® is a trademark of Interlogix Inc. iPod Touch, iPhone and iPad 3G are registered trademarks of Apple® Inc. App Store™ is a service mark of Apple® Inc.

▶ Approvals

For the latest information on products approvals, such as EN, UL and CE, please visit our website at www.paradox.com.

▶ Specifications

Specifications may change without prior notice.

▶ Limited Warranty

Visit www.paradox.com/terms to read the complete text of Paradox's limited warranty statement.

Paradox Worldwide Offices



Bahamas
Headquarters & International Sales Office



Miami, Florida, US
Paradox USA



Montreal, Canada
Manufacturing Center & R&D

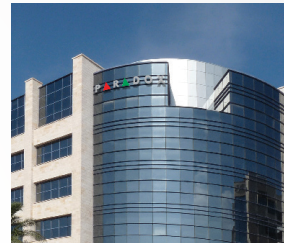

Europe
Paradox Europe & R&D

About Paradox

Established in 1989, our first line of motion detectors featured our breakthrough, patented Auto-Pulse Signal Processing (APSP). By 1996, we offered the first and only fully digital motion detector line in the industry. We continued advancing security technology with our EVO series, featuring built-in access control based on our encrypted expandable one-bus-for-all system. In 2001, we sold our 1 millionth motion detector and launched our award-winning MAGELLAN wireless all-in-one console.

Headquartered in the Bahamas with additional development, production and support centers worldwide, the Company operates a 16,000 meter, state-of-the-art production facility. Paradox holds over 30 patents. Our products meet all global certification standards, including ISO 9001:2008, and ensure the ultimate in high-level security while enabling freedom of movement in secured locations.

Paradox takes great pride in our strong chain of over 65 global distributors. Today, Paradox operates in more than 130 countries, supported by more than 500 professionals around the globe.

In a dynamic and highly competitive market, security system distributors, installers and end-users have come to rely on Paradox's innovative solutions and unmatched customer support and service.

paradox.com

